

The Monroe Preservation Primer: Guidelines for Rehabilitation and New Construction

Prepared for:

**The City of Monroe
and
The Monroe Historic Preservation Commission**

Prepared by:

**Jaeger/Pyburn
Gainesville, Georgia**

September 1987

This study has been funded with the assistance of a matching grant-in-aid from the United States Department of the Interior, National Park Service, through the Historic Preservation Section, Georgia Department of Natural Resources, under provisions of the National Historic Preservation Act of 1966.

Table of Contents

1.0	Introduction	3
2.0	Historical Sketch of Monroe	4
3.0	The Historic Resources	5
3.1	Districts	
3.2	Individual Landmarks	
3.3	Other Local Resources	
4.0	Architectural Styles and Building Type	16
4.1	Commercial Architectural Styles	
4.2	Residential Architectural Styles and House Types	
4.3	Mill Village Architectural Styles, House Types, and Support Buildings	
4.4	Institutional and Public Architectural Styles	
5.0	Design Review in Monroe	25
6.0	Tools for Preservation	26
6.1	Standards	
6.2	Methods	
6.3	Approach	
7.0	Guidelines for Rehabilitation	29
7.1	Commercial Rehabilitation Guidelines	
A.	Adaptive Use	
B.	Commercial Facade Preservation	
C.	Evolution of Storefront Design	
D.	Masonry	
E.	Awnings	
F.	Doors and Windows	
G.	Rear Entrances	
H.	Health and Safety Code Compliance	
7.2	Residential Rehabilitation Guidelines	
A.	Adaptive Use	
B.	Foundations	
C.	The Porch	
D.	Details	
E.	Black Resources	
F.	Energy Retrofitting	
G.	Siding	
H.	Roof	
I.	Additions	
J.	Gutters and Downspouts	
K.	Garages and Outbuildings	
7.3	Mill Village Rehabilitation Guidelines	
A.	Adaptive Use	
B.	The Front Porch	
C.	Wood Siding	
D.	Masonry	
E.	Foundations	
F.	Energy Retrofitting	

8.0	Guidelines for Streetscape Improvements	47
8.1	Commercial Streetscape	
	A. The Sidewalk	
	B. Open Space	
	C. Street Trees	
	D. Signage	
	E. Light Standards	
8.2	Residential Streetscape	
	A. Landscape Design	
	B. Signage	
	C. Street Trees	
	D. Mechanical Systems	
	E. Fences	
	F. Estate properties	
8.3	Mill Village Streetscape	
	A. Streetscape Character	
9.0	Guidelines for New Construction	54
10.0	Rehabilitation Resource Section	60

1.0 Introduction

The City of Monroe has been designated as one of Georgia's "certified local governments (CLG)." The City of Monroe passed an ordinance which established a Historic Preservation Commission. This action made the City eligible to be named a CLG. The mission of the Commission is to protect the historical, cultural, and aesthetic heritage of Monroe for the benefit of its citizens; to stimulate revitalization of the business district; to enhance historic attractions as a catalyst for tourism development; and to encourage the use of federal tax incentives for the rehabilitation of historic properties listed on the National Register. A primary activity of the Commission in carrying out these mandates is to review construction activities in nine historic districts and eight individual historic sites. These historic districts and sites comprise Monroe's locally designated districts and many of these resources are also listed on the National Register of Historic Places.

The purpose of this publication is twofold. First, it is designed as an educational tool to make the local community aware of Monroe's unique history and the many existing historic sites and neighborhoods associated with that history. In addition to these educational purposes, the document outlines a variety of acceptable approaches in rehabilitating these important properties. These are basis guidelines designed for use by the Commission in determining the appropriateness of a construction activity. The guidelines are also aimed at the homeowner or developer for their use in planning a project that is sensitive to the historic nature of the community. Monroe is fortunate to have such a large number of tangible links with its past. Not only is the survival of these resources important, but also the manner in which they are preserved.

The outline of this publication follows this twofold purpose. Awareness of the historic resources is established at the outset through a historical sketch of the community and a section on the historic resources. The historic resources section, divided into district, individual landmarks, and other local sites, includes a description and a short historical sketch of each. An architectural style and building type section follows to illustrate the prevailing architecture found in the community. Architectural styles are related to commercial, residential, mill village, and institutional and public buildings.

The next section of the document deals with design review, the role of the Commission, and how the process works in Monroe. The next chapter, guidelines for rehabilitation discusses appropriate approaches in construction activities related to a historic structure. This section has been divided into commercial, residential, and mill village categories. The next section on new construction is designed for use by the commission in evaluating new buildings proposed to be built in a historic district or for use by the applicant in designing a new building in one of Monroe's historic neighborhoods. The principles of new construction, such as the reflection of neighborhood scale, form, and materials in new buildings, are explained and illustrated.

The rehabilitation resource section is the reference part of this document. This section is generic and would be appropriate in guidelines for almost any community in Georgia. The purpose of this section is to give the applicant more detailed information on a specific component of a rehab project. This section is designed to first assist the applicant in defining the problem. Once the problem is understood, general principles of rehabilitation are noted. Then a variety of solutions to consider are listed. Each topic also includes a listing of additional sources to consult if more detailed data is required. The publication ends with a bibliography.

2.0 Historical Sketch of the Community

Settlement began in the Monroe area in the 1810's. Farms scattered the countryside and a blacksmith's shop and tannery were built on the present-day site of Monroe to service these farms. More buildings followed and by 1821, the village was named Walton Court House in an effort to be designated the county seat. It became Monroe and secured the seat later in that year. A gridiron pattern was laid out for the town which centered around the court square. Residential development began within a block of the courthouse and by 1827, Monroe had 41 houses, a courthouse, jail, and academy. It also had 11 stores, offices and shops. In the 1830's, development started on the fringes of the community. In 1857, a fire dampened the town's growth and destroyed much of the business district. The Civil War slowed development for 15 years until 1880 when the building of the Walton railroad from Monroe to Social Circle brought renewed growth to the community. Rail connections to Atlanta and Augusta were the key to this growth which later led to the opening of a Monroe to Gainesville rail line later in the 1880's.

With renewed activity, construction activity increased in the central business district, with the building of the three-story Walton Hotel. A new courthouse and jail were constructed and by 1888, 15 brick stores were located near the courthouse. Construction of the McDaniel-Tichenor House on McDaniel Street in 1887 marked the outward expansion of the town which continued through the 1890's and 1900's. The street plan broke away from its previous gridiron pattern and became irregular in nature. One and two-story Victorian era houses developed east of the central business district, along Highland and Walton Streets. Industry grew during this period as well, beginning with the Monroe Guano Company in 1889. Industries tended to develop south of the central business district, along the railroad line. The Monroe Cotton Mill Company was established in 1895. The Monroe Mill was followed by the Walton Cotton Mill Company in 1900. As a result of the industrial expansion in Monroe, the central business district began to expand. Many of the new buildings constructed during that time still stand today. The Nunally Building, the B.S. Walker Block, and Monroe Mercantile Company all faced the courthouse on Broad Street. The three-room Felker Block was built opposite the Walton Hotel in 1897 and featured a recessed glass front, iron awnings, and brick sidewalks. Several of the large homes near the courthouse were converted into boarding houses and during this period, the Mobley Opera House became a part of the Central business district. This rapid growth in the late 1800's brought new services to Monroe in the early 20th century. A water and light plant was built on the northern edge of the city limits, while in 1906, a public school system was established. The town's first planned neighborhood was developed at this time and was called Monland Place, along Alcova and Boulevard Streets. It was built with restrictive covenants as to the size and setback of the houses. Maple Heights, a black neighborhood, was also developed at this time. The 1910's and 1920's saw the continued outward expansion of Monroe. The outer edges of the East Church Street area and the East Marable Street area north of the Central business district, have frame houses dating from the second and third decades of the 20th century. New homes and housing for blacks was built north of Marable Street. These structures were mainly simple frame shotgun or duplex houses.

In 1920, a three-story brick hotel was built on Broad Street. Public improvements also began during this period, such as the paving of Broad Street in 1920. The Depression of the 1930's hurt Monroe and slowed building, but a few important structures of the town were constructed during this decade. A new post office, later used as a library, was constructed in 1932 and in 1939, City Hall was built on the same block as a WPA project. After World War II, development picked up in Monroe. New commercial buildings were built downtown while strip development and new shopping centers were located west of the town.

3.0 The Historic Resources

Historic resources in Monroe are primarily those which were identified through a Multiple Resource National Register Nomination, prepared in 1983. The nomination proposed the National Register designation of nine historic districts and five individual properties. The Historic Preservation Commission's jurisdiction in Monroe covers these districts and individual sites identified in this nomination. Since Monroe's history is also represented through other locally important sites, this section has been designed to include other important local resources. Monroe's historic landmarks and districts are illustrated on the following map. The properties listed on the National Register of Historic Places are noted in a larger type size and include the following districts: (1) Monroe Commercial Historic District; (2) North Broad Street Historic District; (3) Monroe and Walton Mills Historic District; (4) South Broad Street Historic District; (5) McDaniel Street Historic District; (6) East Church Street Historic District; (7) South Madison Avenue/Pannell Road Historic District; (8) East Marable Street Historic District; and (9) Monland Place Historic District. National Register individual properties include (1) A. J. Boss House; (2) Monroe City Hall; (3) Walton County Jail; (4) Williamson House; and (5) Chick-Gower-Braswell House. The locally important sites, noted in the map in slightly smaller type, include (1) Felker-Lott-Conner-Briscoe House; (2) Oakes Hardware; and (3) the Georgia Railroad Depot. There also appears to be an area adjacent to the McDaniel Street Historic District along Washington Street which contain a collection of structures associated with Monroe's black population. This area warrants additional study for potential inclusion in that district.

3.1 Historic Districts

Monroe Commercial District

Description - The district, developed around a courthouse square in a gridiron street pattern, is a late 19th century commercial area, with one and two-story brick buildings. This area was the first to develop in the city. The district is small, unified, and densely populated. Facades are generally located at the street, with no setback and the commercial buildings abut each other. Public buildings in this district tend to be large structures with designs that reflect their public purpose. The structures have a Victorian character in most instances, with brick corbelling, decorative grills, arched



windows, iron storefronts, and large display windows. The classical revival styles and utilitarian styles are most prevalent in this area. Alterations over time has obscured some of the high quality craftsmanship of the buildings in the downtown district and most of the alterations involved the covering of the facade with a metal storefront and interior changes such as lowered ceilings. The only major landscaping feature is the courthouse square.

Historical Sketch - Monroe's present-day central business district is the site of the town's first development. An early blacksmith's shop and tannery were followed by several log houses and a post office. After its designation as the county seat in 1821, the town center grew and government offices began to play a major role in shaping the central business district. A brick courthouse was constructed in 1823, as well as the county jail. In the earliest development of the downtown, government offices, businesses and residences were all clustered together. In 1857, a fire swept through Monroe which destroyed a majority of the business districts and several dwellings. The courthouse was saved, convincing the townspeople of the value of building with brick. After the construction slump during the Civil War, downtown development began to boom with the building of railroads in the 1880's. The Walton Hotel and Walton County Courthouse were two major structures built in the area during the latter 19th century. With the coming of the 20th century, Monroe had a thriving central business district. The Mobley Opera House was built as was the Monroe Public Library at this time. By 1910, the CBD was growing into areas that were traditionally residential in nature. Growth during the 1920's and 1930's continued in the earlier pattern of Monroe while two new public buildings were constructed. The classically inspired post office was built in 1932, and the Monroe City Hall was completed in 1939. After 1940, development slowed downtown and when it picked up again in the 1950's and 60's, its character was such that it harmed the historic character of downtown Monroe. Only in recent years have businessmen been interested in sensitive rehabilitation and the preservation of their older buildings.



North Broad Street Historic District

Description - The North Broad Street district is essentially a turn-of-the-century middle and upper-middle class residential area. A few earlier houses exist, usually fine Greek Revival and Victorian era structures. Most of the buildings are frame and brick, two-story residences, sited on large lots. Classical and colonial styles predominate the area. The area was developed as a residential neighborhood on the north side of the central business district. The district is fairly unified in nature. Streets are generally laid out in a gridiron pattern, although both North Broad Street and North Midland Avenue curve at their northern end. Block sizes are not uniform and lots are generally large, except along the eastern side of North Broad Street. These buildings are closer together with more "urban" characteristics.

Historical Sketch - Soon after the founding of Monroe, residential development began north of downtown, centered along Broad Street. The first part of this development came in the block between Spring and Highland Streets, an area which is commercial in nature today. Little construction took place

north of Highland Street because of Monroe's slow growth prior to the 1890's. There were a few notable residences built in this area at this time, however. The most important of these was the Davis-Edwards House which is listed individually on the National Register. This house dates to the 1840's and is a fine example of Greek Revival architecture. It was originally built in an open area, but new development had surrounded the house by the time it was sold in the 1880's. The coming of the railroad brought new industry and growth to the area in the 1880's and 1890's. Frame Victorian era styles were constructed along North Broad and Highland streets. At this time there were no buffers between the CBD and residential area.

By the early 1900's, the North Broad Street area had been extensively developed. Most of the houses were of frame construction, were relatively large, were sited on large lots and were classically influenced. With the growing development, public services such as electricity and water systems were improved in the area. An informal subdivision of land took place in 1907, when C.G. Nowell plotted 24 lots between Walton Street and Highland Avenue. The lots ranged in size from 1/3 to almost one full acre. Between 1910 and 1930, construction in this area, on the fringes of the district, marked the final phase of development for the district. Houses and lots remained large and brick was used more often. The bungalow plan and other modest styles were built.

Monroe and Walton Mills Historic District

Description - The district is an industrial complex of late 19th and early 20th century structures with a few exceptions. Several Victorian-inspired houses existed in the area prior to the mill village development. The construction of the Monroe Mill in 1895 and its adjacent housing, stimulated development in this area. The Walton Mill and its housing were constructed five years later and both areas share the same type of construction. The two mill complexes are of brick construction and typical of the period in which they were built. The mills' houses are generally made of wood. The house designs are small and plain. Commercial and religious structures built at the turn-of-the-century are also present in the district. The area is divided into four parts: the mill buildings themselves, "support buildings," such as churches and schools, mill houses, and South Madison Avenue, where several large houses are

located. All the streets in the district relate to either South Broad and South Madison and are laid out in a gridiron fashion which does not correlate to the natural terrain, which is typical for mill villages. The mill houses have small front and large rear yards and face the street at right angles. The mills houses are mainly variations of the shotgun house or two-story duplex. They are all very simple with emphasis on porches. Many have porches on both the front and back. The commercial, religious, and educational buildings in the district are also very simple in nature. The craftsmanship of the mill village seems to be very much alike to other mass produced mill villages in Georgia. Large trees line the streets in the mill village to define and reinforce the gridiron pattern.

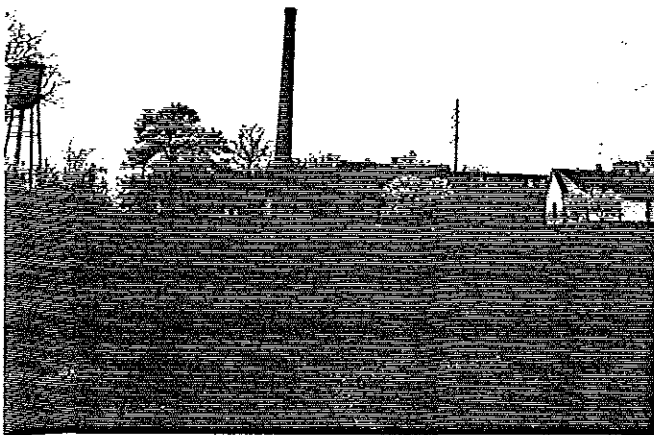

Historical Sketch - One of the earliest industries to come to Monroe with the building expansion and railroads was the Monroe Cotton Mill Company. The mill was chartered in 1895, and became a part of the state's late 19th century growing textile industry. The village which surrounded the mill was named "Carson." By 1897, 30 new mill houses were under construction, bringing the total number to 75, with 600 inhabitants. Other institutions began moving in to serve the growing mill community. A church was built shortly before the turn-of-the-century near the mill and a school was also built nearby for the village residents.

In 1900, the Walton Cotton Mill Company was formed and frame mill houses were constructed south of the mill in a gridiron street pattern. Both mills prospered in the early 1900's and both enlarged their facilities. At this time, industrial and residential development moved southward, toward the mill. The 1920's and 1930's saw continued growth for the mills. By 1924, Mill, Salem, and Ripley Streets were lined with houses. Stores were built at this time in the village to meet the needs of new residents and also, a frame recreation hall was built for mill employees.

The mills continued to expand and merged in the 1970's. The Walton mill village has a great number of historic buildings still intact although mill expansion did destroy some earlier housing. The development of the mill industry is well illustrated by the buildings that stand today.

South Broad Street Historic District

Description - This district is predominantly a small residential neighborhood which dates from the mid-19th century. Early homes were situated on large lots in a rural setting. Later, the lots were infilled. There are several large and architecturally important houses in the district, while the later homes are generally more modest. The primary construction material is wood and styles range from the plantation plain house types to early 20th century townhouses. The street curves at the northern edge of the district and breaks with the gridiron street pattern. The lots are irregular in size and there seems to be little relationship between the street layout and the natural terrain. Development is denser at the south end of the district. Informal landscaping pervades most of the district which creates a pleasant, natural setting.

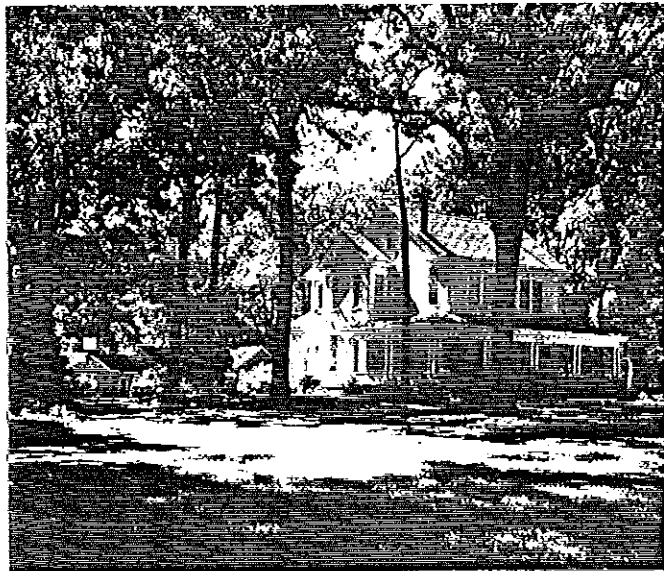

Historical Sketch - For many years in the 19th century, South Broad Street was a fashionable residential address. Large frame houses were common on several parts of the street but when commercial and industrial pressures came from the north and south, part of the neighborhood was demolished and the remaining sections were confined. Early South Broad Street homes usually sat on large lots connected with the owner's major landholdings. Beginning in the 1880's to the 1920's, Monroe expanded commercially and industrially and the new homes on South Broad

Street reflected this new affluence. These new homes featured decorative scrollwork, bay windows, large porches, and other Victorian era features and detailing. Later homes were less decorated but still kept the same massing, proportions, and siting found in the earlier houses. Development on South Broad Street after 1920 was on a smaller scale. Residential growth was stopped east of the district because of warehouses and industries locating along the rail lines there. Walton Mill's plant was just south of the neighborhood which blocked development in that section while the central business district extended into the northern end of the district. By this time, it was not as fashionable to live in the South Broad Street neighborhood as once before. From the 1930's to the present, there have been many intrusions and changes to the area. Commercial and strip development has located within the district, and several residences now operate as offices.

McDaniel Street Historic District

Description - This is a primarily residential area with buildings that date from the 1830's to the 1930's. Various architectural styles are represented in the district of very large and fine houses. Lots in the district are generally large with well maintained landscapes. A small cemetery, associated with the original Baptist Church building, the existing Baptist Church, and a portion of a black neighborhood is also a part of the district. The most common styles of architecture in the district are the Neo-Classical and Bungalow. In the western part of the district, the buildings are much more imposing in nature and are straightforward and simple in design. Victorian and Colonial Revival influences can also be in this



district. Most of the district is well landscaped with a naturalistic appearance.

Historical Sketch - McDaniel Street began as a part of the agricultural land surrounding the new village of Monroe. Some of the earliest development on McDaniel Street was tied to the agricultural base of cotton. The area was slow to develop and was marked by large homes on extensive lots. The first development in the McDaniel Street area was at the intersection of South Broad Street on the site of the First Baptist Church. In 1829, the First Baptist Church was organized and a small frame structure was built near the site of the present church. In the 1830's, one of the most important homes in the district was built, the Briscoe-Selman-Pollock house. Additions were

made to give the house 15 rooms by the 1870's. Little development occurred during the mid-19th century in the area. In the 1880's a new period of growth came about when the Baptists built a second building and in 1887, Henry Dickerson McDaniel built his home on the street. This possibly marks the transition of the district from rural to suburban in nature. The industrial growth of Monroe in the late 19th century brought growth to the McDaniel Street District as well. From the 1880's to the 1900's, frame Victorian houses were built at the eastern edge and central part of the district. The final period of development for the area happened from 1900 to 1930. Large houses were built facing Broad Street at the eastern end of the district. The present First Baptist Church was built in 1915 and in 1916 the Walker house was built

as a two-story, brick, colonial style house opposite the McDaniel-Tichenor House. During this final phase, the housing in the McDaniel district took the form it has today. Frame and brick veneer homes which reflect the mixture of commercial and residential uses in the area were built in the northeastern edge of the district before 1916. After the 1930's, development subsided in the district, but as in other areas of Monroe, the 1950's and 1960's brought new development pressures on the edge of the district by both residential and commercial structures. Nevertheless, the area has retained its historic character as a middle to upper-middle class neighborhood.

East Church Street Historic District

Description - This district is mainly residential and developed in the late 19th and early 20th centuries along East Church Street. The residential structures in the area differ in style, size and building material. Bungalows and the Neo-Classical style pervade the area while there are a few Victorian era homes remaining. Although the area is essentially residential, it acquired an important educational function in the early 20th century with the building of the new public schools. As the area prospered, development both to the north and south of East Church Street took place. Most buildings face the street at right angles at similar setbacks. Because lots are small and the houses are close, the area has a more urban feel than the McDaniels or North Broad Street areas. The landscape is informal and large trees shade the area. Few walls exist.

Historical Sketch - The growth experienced by Monroe during the late 19th century from the railroad lines and industry spurred development of the East Church Street District. Concentrated at the western end, large frame houses were constructed throughout the district. These houses ranged in size from modest to grandiose and Victorian detailing and styles are more prevalent here than anywhere else in Monroe. Three important public buildings were constructed along East Church Street in the early 1900's. Monroe High School, a round brick structure constructed on the north side of East Church Street in 1900, the Junior High, built in 1914, and the First Christian Church, built in 1910. Both schools were built as a part of the public school system which was established in 1906. Although large frame homes were being constructed in the district at the turn-of-the-century, smaller, more middle class homes became prevalent in the area in the 1910's and 1920's. The main style built at the time in the East Church street area was the bungalow plan with Craftsman detailing. Industrial development along the railroad in the early 20th century stopped residential growth to the west. Most of Church Street as it exists today, was developed around 1916 and this development was fairly dense. Later development replaced earlier buildings in many cases. In 1930, the historic development of the district ended and since then, many of the older homes have been severely altered or demolished. Modern industrial development has changed the character of the district to the west.



South Madison Avenue/Pannell Road Historic District

Description - The district developed on an important crossroad leading out of the community. Earliest homes were probably farmhouses, with one and two story frame structures developing later in the 1870's and 1880's. House size and design varies. From the 1940's to the 1970's Monroe's growth reached the area and infill housing was built. The area is very flat and relatively uniform in character. Lots were laid out with little attention to the terrain. Plain, wooden structures and Victorian-era embellished homes exist in the area. Large lawns are a feature of the area and informal landscape treatment is prevalent in the area.



Historical Sketch - A small hamlet developed on the outskirts of Monroe in the early 1800's at the point of two crossroads which consisted basically of a cluster of farmhouses. The village was called Cowpens (later named Pannell) and served as a temporary county seat. Even after Monroe began its growth, the area stayed a close knit community. Pannell Road has been an important road in Walton county because of this activity. By the 1880's, homes that remain in the district today were built at the crossroads. All of these homes consist of simple frame construction, with vernacular floor plans popular in the region at that time. Despite their basic simplicity, most all have very fine Victorian porches and some of the detailing extends to

gables and rooflines. By 1920, most of the significant buildings were constructed and the location of two cotton mills on the south side of Monroe pulled development in this direction. Unfortunately, infill during the 1960's and 1970's occurred along the street, which brought new development along Pannell Road.

East Marable Street Historic District

Description - The East Marable District is a late 19th and early 20th century residential area. It developed as a middle class residential neighborhood to the north of the North Broad Street. The buildings in the district are all located on the north side of East Marable Street and are generally one-story, modest frame houses. The racial makeup of the area was white, and was separated by the railroad from the black residential section to the west. The houses maintain a uniform setback fairly close to the street and are Victorian in nature. They have large porches, decorative scrollwork, asymmetrical floor plans, and turned balusters. The 20th century buildings are simpler and have Bungalow features.



Historical Sketch - As the middle-class grew in Monroe during the last quarter of the 19th century, new, and usually unplanned residential districts were developed to house them. The East Marable District was one of these districts. New development in Monroe always seemed to happen at the northern edge of town and Marable Street was initially a road leading out of town in a rural setting. The early property owners in the East Marable district were well-established families who began selling off their properties in the late 19th century. The earliest remaining houses in the district date from the 1880's and are typical middle class dwellings for that time. They are modest, one story frame dwellings and while the earlier structures are decorated, the 20th century dwellings are more plain in ornament. After the turn-of-the-century, development grew rapidly in the area but when the Electric Light and Water Works plant was built in 1905 at the western edge of the district, growth stopped in this direction and broke the connection with the North Broad Street area. By 1916, the majority of the houses remaining in the district today had been constructed. Later phases of development in the 1930's and 1940's involved the construction of rental property. Development ceased after this period but after World War II, growth continued south of East Marable and along North Madison. The district remains basically unchanged and still reflects its turn-of-the-century character.

Monland Place Historic District

Description - Almost all the buildings in Monland Place are one-story, frame structures with full-length or encircling porches. The earlier homes reflect earlier Victorian styles, while later buildings draw more on the new 20th century styles. A few of the homes have characteristics of the Craftsman style and Bungalow house plans. Many have a heavy dependence on pattern books. Porches are less important



and detailing is subtler than on the Victorian homes.

Historical Sketch - In the late 19th and early 20th centuries, Monroe developed into an industrial town. The population grew, and although many new residents were involved with the industries, a growing number were middle-class businessmen and shopkeepers who worked for the town's service establishments. There became a need for more housing since the residential area near downtown was small. In 1906, Charles Walker owned a house and plot of land southwest of the Central Business district and McDaniel Street. Walker was a leader in Monroe and developed the first planned subdivision in the town. He subdivided his land in October of 1906 into 79 lots and a substantial amount of promotion accompanied the sales. A contest was held to name the subdivision and the winning entry was Monland Place. Restrictive covenants were attached to the lots to encourage good development. These restrictions included: Houses had to cost at least \$1,000, and sit 15 feet from the street. Also, no homes were sold to blacks. Sales flourished from 1906 into the 1920's. Monland Place became fairly extensively developed. Homes were convenient to downtown and middle class business and professional men were the standard residents. By the 1930's, development effectively ended and few intrusions have come to the area. Today, some commercial structures block the historic qualities of the area and the building of the First Methodist Church in 1950 has prevented any more residential or commercial expansion to the south.

3.2 Individual Landmarks

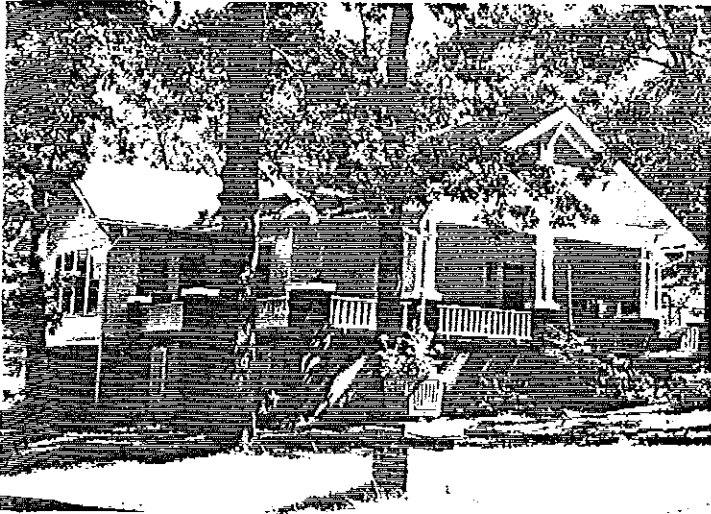

A.J. Boss House

The A. J. Boss House, located at 324 Edwards Street in the North Broad Street area of the city, was constructed c. 1916. This home is an excellent example of the bungalow plan in Monroe. The one-story frame house has craftsman detailing. The house sits on a corner and is in good condition. The house was built for Dr. A.J. Boss, a dentist in the community in the early 1900's.



Monroe City Hall

This building, located at 227 South Broad Street, is important because it represents a style in stark contrast to other buildings in Monroe. Built in 1939, as a WPA project, it represents Monroe looking to the future at the end of the Depression. It consists of a two-story Art Deco block building with projecting one-story wings on both sides and metal windows typical of the era.

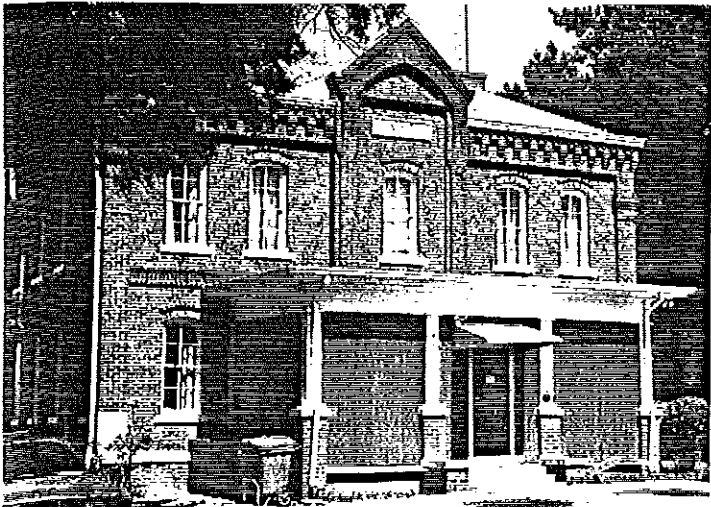

Walton County Jail

The Walton County jail, located at 203 Milledge Avenue, is important because it exemplifies small jail architecture of the 1880's. It has Romanesque details and has extensive brick detailing around the eaves. A center gable protrudes and the front porch has been enclosed. The jail is in fair condition and has had a few alterations. The jail was the third jail built for the county.

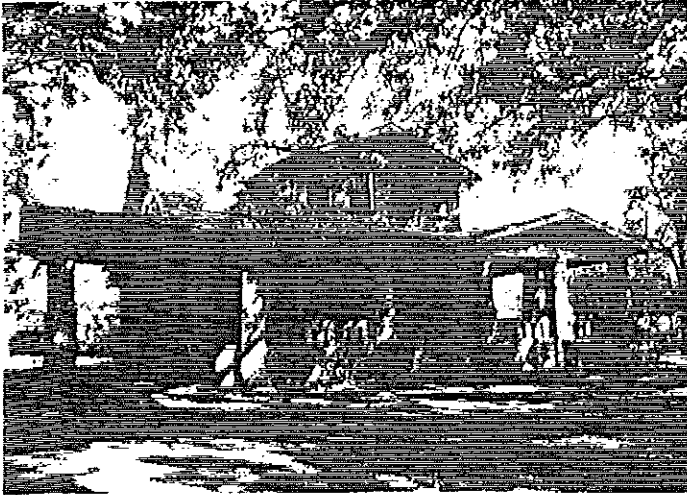

Williamson House

Although this house, located at 925 East Church Street, is similar to other homes in Monroe because of its Bungalow plan, it is unique for its brick construction, size, and greater use of details. It has a steeply pitched roof, extensive porch, a porte cochere, large brackets under the eaves, and brick detailing. It appears massive because of its masonry construction. Because it represents a fuller representation of a house plan so popular in Monroe, the house is a significant architectural landmark. Hugh B. Williamson, the original owner, was a merchant in the community in the early 1900's.

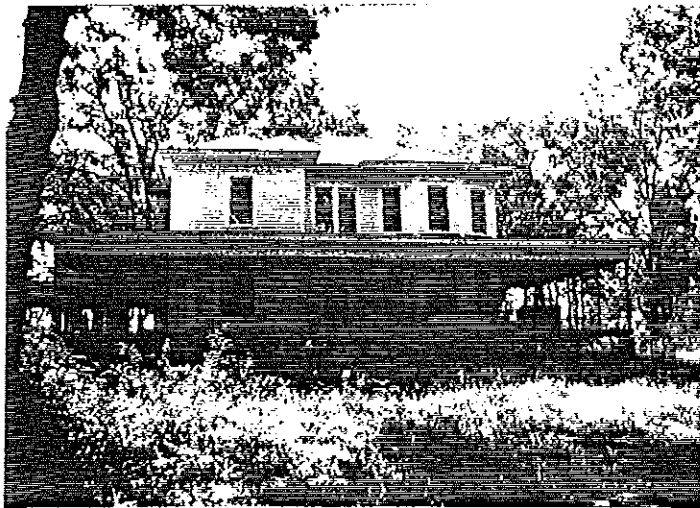

Chick-Gower-Braswell House

The Chick-Gower-Braswell House at 1102 East Church Street was built c. 1907. At the time it was built, this two-story frame farmhouse, was considered to be "in the country," but it is a good example of early 20th century architecture built for a middle-class family moving into the city. It was close enough for them to take advantage of Monroe's new school system. The details of the house include: a one-story porch that wraps around the west side of the house, simple door surrounds, a bay window, square columns, and brick chimneys. Today the building is in fair to poor condition but is important because it is a rare example of this house type still in the city.

3.3 Other Local Resources

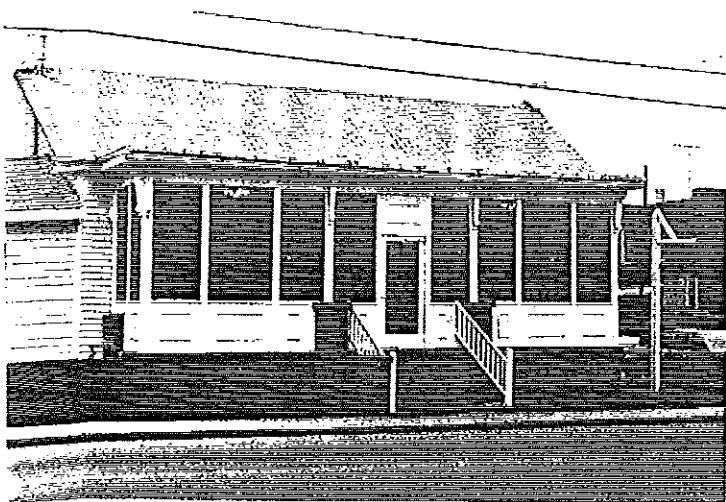

Felker-Lott-Conner-Briscoe House

The Felker-Lott-Conner Briscoe House, built c. 1820, is located at 116 East Highland Street. The house is a one-story frame structure with many additions. Some of its characteristics include: double doors on the front facade, simple 20th century porch, brick foundation and chimneys, and wide wood flooring. The original owner, Stephen Felker, who came to Monroe from South Carolina, was a contractor and businessman.



Oakes Hardware

This one-story brick warehouse, located at 216 Davis Street, is one of the few remaining unaltered warehouses. Built in the 1920's, it was a part of an industrial complex associated with cotton and the Monroe mills. Some features of the building include: a slightly pitched roof, large and arched door openings, and some decorative work in the gable front. The building is in good condition and is generally unaltered.

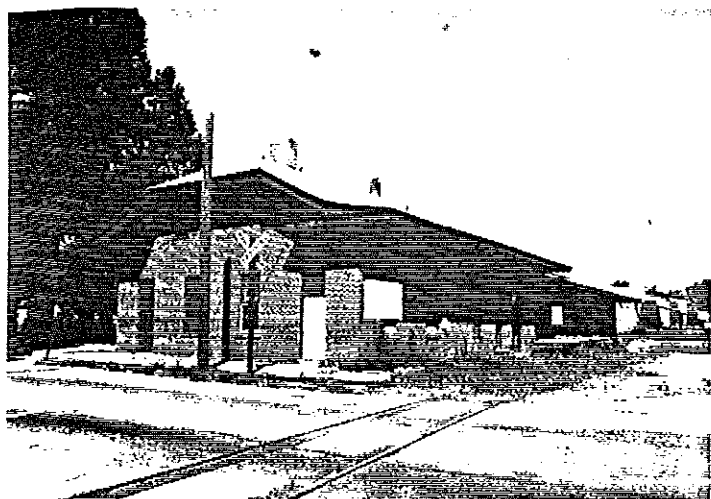

Georgia Railroad Depot

Although this structure was extensively altered in the 1930's, it still retains its basic form as an early 20th century railroad depot. Located at 115 Davis Street, the building is a symbol of rail transportation in the development of Monroe.

4.0 Architectural Styles and Building Types

4.1 Commercial Architectural Styles

The styles found in Monroe's commercial district represent approximately 100 years of architectural development. Regardless of age, most buildings within the Broad Street district follow a basic form. To this form, a variety of details were added to create the distinct architectural styles.

The Whole Building

A typical commercial building features a facade with an ornamental cornice serving as a cap to the building; double-hung windows on upper floors, the type varies with the style of the building; pilasters which express the structural bays of the building; a continuous lintel which separates upper floors from the storefront; and a storefront contained under the lintel and between masonry piers.



Cornice

Double Hung Windows

Lintel

Pilaster

Storefront

The Bottom of the Building

The typical storefront includes a lintel which separates the upper stories from the ground floor and is an appropriate location for signs; masonry piers carried from upper floors noting the bays of the building; windows with vertical proportions, many times with transoms above; heavy sills; wood or cast iron columns forming the structure of the storefront; wood or cast iron kick plates; and wood and glass paneled doors, which are sometimes recessed.

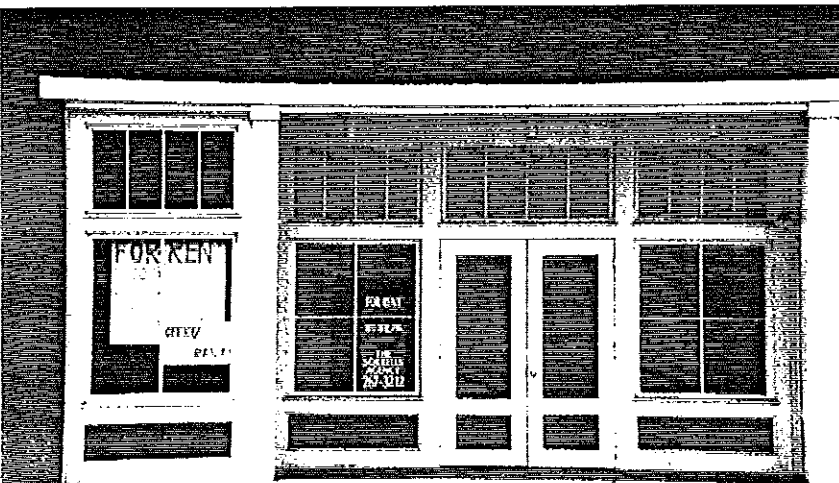

Lintel

Transoms

Masonry Piers

Display Windows

Wood/Glass Panel Doors

Wood/Iron Columns

Kickplates

Historical Styles Found on Broad Street



Vernacular - The majority of the buildings in the district are one and two-story brick buildings with brick corbelling in the cornices.

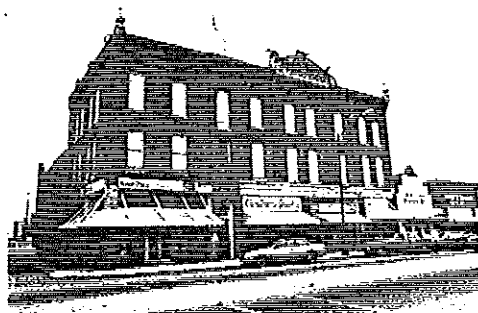

Eastlake - The Walton Hotel is a Victorian era structure with Eastlake detailing reminiscent of the Queen Anne style. Intricate ornamentation which gives the appearance of hand tooling, is actually cast iron. Also, note the turret on the roof which is characteristic of this style.



Spanish Colonial - There is one building in Monroe's downtown which has characteristics of the Mediterranean style. Although the structure is of brick, it has the appearance of stucco. The structure also has a Spanish style parapet and ornamentation.

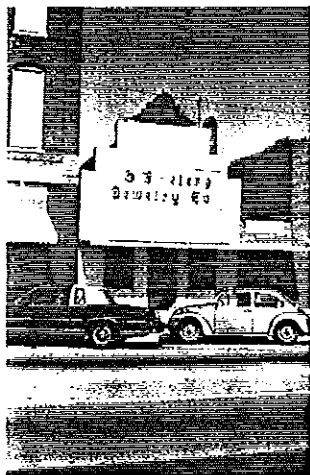

Eclectic Commercial - This building displays a Flemish styled parapet under its aluminum front, a unique design element in a small Georgia town.

4.2 Residential Architectural Styles

House Types

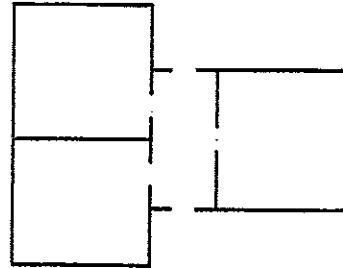
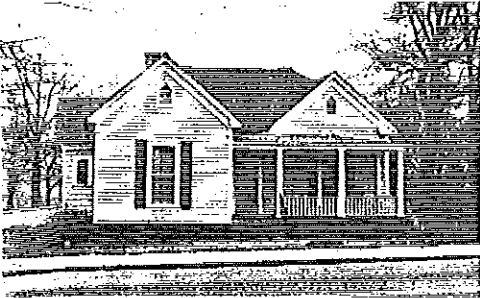

The "L" - This house plan is easily definable as it is shaped like an "L." A gabled end usually faces the street and the main part of the house extends from the "L."

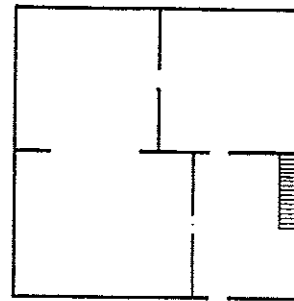

Four Square Plan - The Four Square house plan has a boxlike shape and hipped roof. It is a simple and practical style and is easily adaptable to many styles with a change in window style, porch detail, or exterior material. The plan could accommodate one or two-story dwelling and was used heavily in Monroe's historic residential districts.

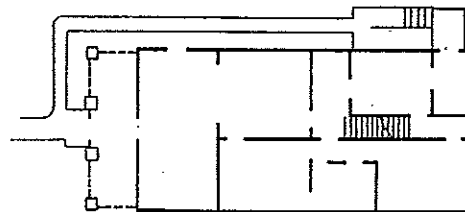

Bungalow - The Bungalow house plan is very prevalent in Monroe's residential areas. The plan consists of a small, usually one and a half story dwelling with a low-pitched gable roof and an asymmetrical interior floor plan.

Residential Styles



Greek Revival (circa 1820's - 1860's) - The Greek Revival style is evident in Monroe's residential district in vernacular structures. Characteristics include a pedimented portico supported by columns, a transom surrounding the doorway, and wood siding.



Queen Anne (circa 1880's - 1910) - The Queen Anne residential style is characterized by an asymmetrical house plan and detailed surface ornamentation, such as turned porch spindles and gingerbread woodwork. Architectural features of the Queen Anne dwelling include: turrets, bay windows, and wrap-around porches.



Vernacular Victorian (circa 1880's - 1910) - Some of the same features found on high styled Queen Anne dwellings can also be found on vernacular house types. The ell-shaped house plan often has Victorian details such as gingerbread-work, turned spindles, and elliptical windows.

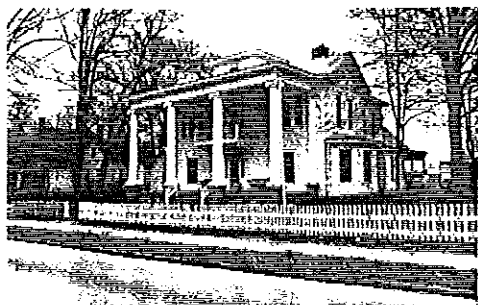

Neo-Classical (circa 1895-1950)- This style consists of classical detailing on a Four Square house plan. Ionic and Corinthian columns supporting two story entry porches, one-over-one windows, and gabled or flat roofs are some features of this style.

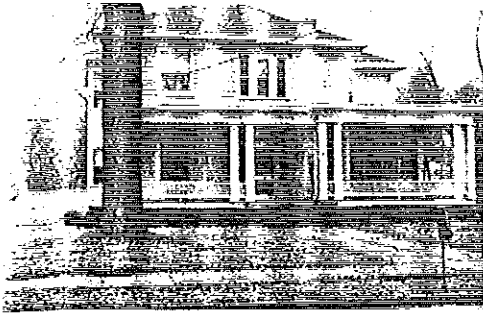

Prarie (circa 1895-1910) - The Prarie style adds specific detail to a basic Four Square house type. This style emphasizes the horizontal, such as broad, low eaves, long porches, Roman brick, and bands of windows.

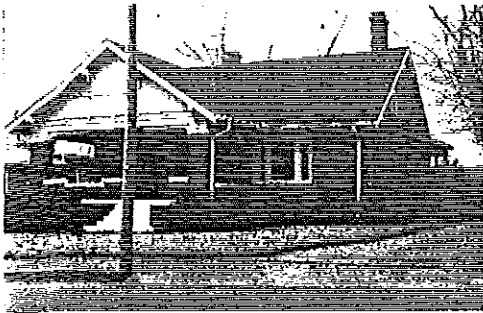

Craftsman (circa 1905-1930) - The Craftsman style house usually has a Bungalow plan with Craftsman details. These details include: “natural” construction materials such as stained shingles, fieldstone, and wood. The most revealing feature of a Craftsman style house is its large front porch with large supports.



Colonial Revival (circa 1920- 1950) - The Colonial Revival style in a vernacular form, is popular in Monroe’s historic residential districts. It is usually a one story dwelling with the following features: shutters, a pedimented stoop or front porch, and wood siding.



Tudor Revival (circa 1930’s - 1950) - The Tudor Revival style is distinctive and easily recognized. The entryway is almost always gabled. The interior floor plan is asymmetrical and the house is usually one or one and a half stories. Some of the features of the Tudor Revival Style are its brick construction, half-timbering, and its steeply pitched gabled roof.

4.3 Mill Village Architectural Styles and House Types

MORROE's mill village contains not only many house types, but examples of support structures worth noting. Most of the mill residences illustrate vernacular house type forms while a few examples of early Victorian dwellings are located on the southern edge of the district.

Mill Village House Types

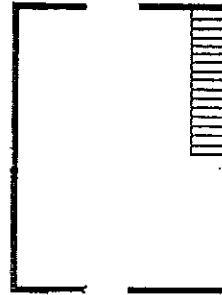
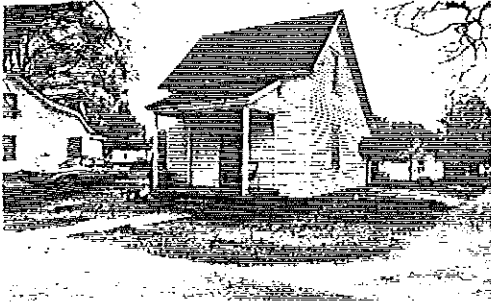

Shotgun Saltbox - The saltbox shotgun is a simple, one room deep dwelling, usually having a dropped entry porch. The saltbox form is its most dominant characteristic. These structures have one and a half stories and wood siding.

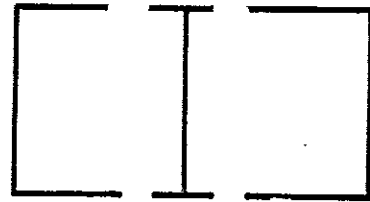
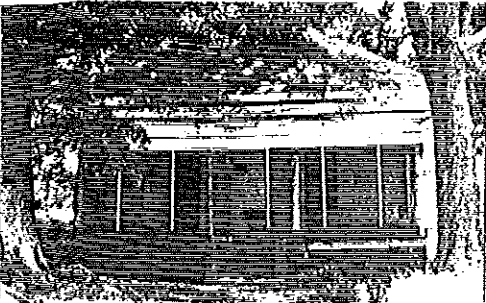

Double Pen with Hipped Roof - The double pen house plan is characterized by a central chimney and two front doors with windows on either side of the doors. The roof may be gabled or hipped. This example shows a hipped roof. A dropped porch is common on the double pen, as well as wood siding.



Double Pen with Gabled Roof (facing the street) - This house type is the same as above with the exception that the side gable is oriented to the street, and in this case also the railroad. This is a unique mill village house type.

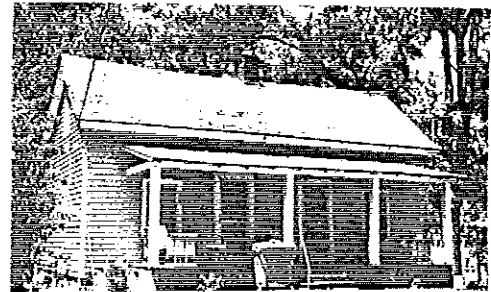

Double Pen with Gabled Roof- This house type has identical plan and details to the above, but features a gabled roof.

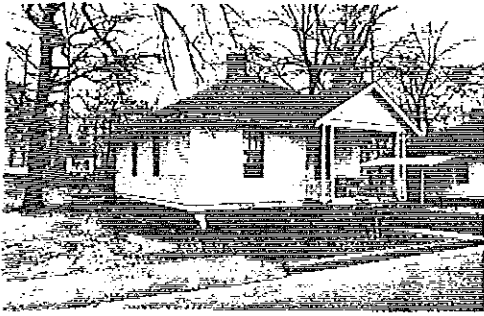

Pyramidal Roof Cottage - This common house type features a pyramidal roof, central chimney and recessed porch with a gabled portico. It is a square, boxlike house, constructed of wood with exposed rafter ends.

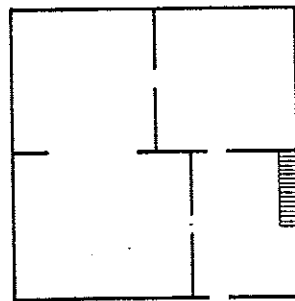

Four Square - These houses illustrate the rarely seen two-story mill village dwelling. The plan is a simple boxlike house with hipped roof, one story porch roof, and a pier foundation.

Mill Village Styles

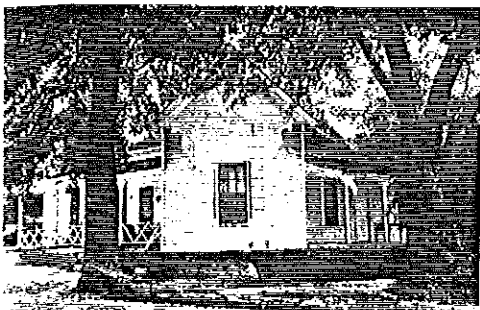

Victorian Era Cottages - The only house style found in the mill village is the Victorian Era cottage. These are along Madison Road and represent dwelling which predate the mill complex. Their characteristics include: Eastlake ornamentation, such as turned spindles, decorative barge boards, and multi-gabled roofs.

Support Buildings

Besides residential structures, the mill village contains a variety of historic buildings which supported the community's needs. These buildings include stores, churches, and schools and the mill complex itself.

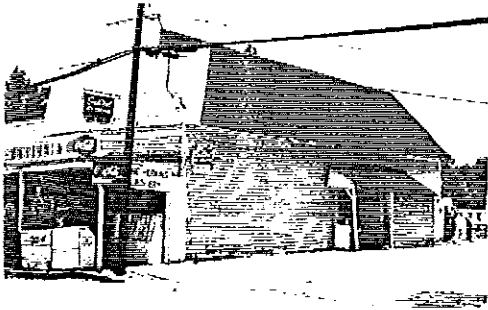

Corner Stores - A few store structures remain in the mill village, some still in use, and others abandoned. They are of wood and brick construction and many times feature a front porch. The stores were generally plain and utilitarian. Roof shapes vary. Most are gabled while this example has a parapet fronting the gable and has a flat roofed addition.



Churches - Several churches located within the district served the spiritual needs of the district's residents.



School - The brick school building exhibits more detail in its design than the stores and residences. It served a social as well as educational need for the community and was one of the focal points of the community.

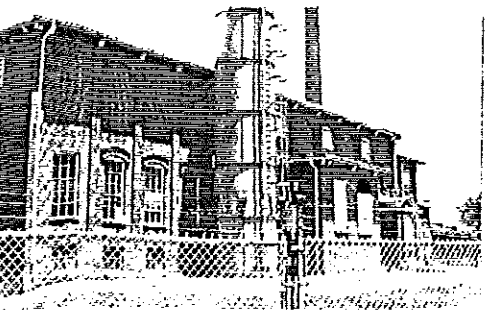

Mill Complex - The mill complex is one typical of the early 20th century. It is composed of two-story brick structures with large multi-paned windows with a bracketed overhang. The smokestack is also brick.

Institutional and Public Architectural Styles

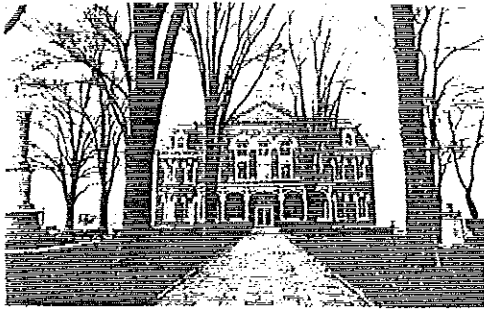

Second Empire (circa 1860-1900) - Monroe's Court House, built in 1884, is an example of the Second Empire Style, with its mansard roof, dormer windows, hooded windows, tower, and decorative brackets below the eaves.

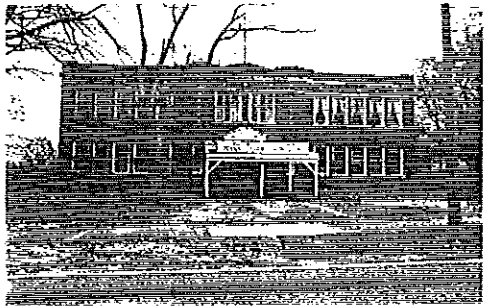

Neo-Classical (circa 1895 - 1950) Built in 1915 and located on East Church Street, the Monroe High School is a two-story, brick building, typical of school structures of that era. It is symmetrical with bands of windows on both sides of the slightly protruding pavilion.



Classical Revival (circa 1895-1950) - Monroe's present day library was built in 1932 and served as the city's post office. The building, constructed of red brick, is classically inspired, with its rounded portico, ordered columns, and rectangular shape.



Art Moderne (circa 1920-1940)- City Hall is an example of Art Moderne architecture, built in 1939 as a WPA project. It is the only structure of this style in Monroe. Its characteristics include: squared features, a horizontal tendency, several paned windows, and a smooth exterior texture.

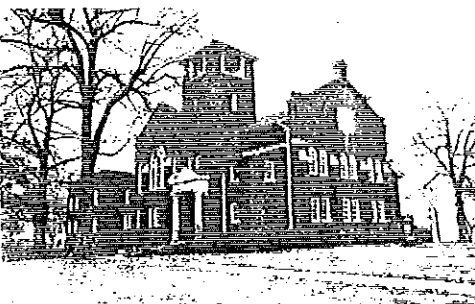

Spanish Colonial - The first Baptist Church, located on McDaniel Street, illustrates a Mediterranean style, and was built in 1915. The style is defined by its brick construction, square bell tower, paired windows, and parapets.

5.0 Design Review

A person planning a construction activity in the City of Monroe is required by local ordinance to obtain a building permit prior to beginning the work. An application for the permit is made at City Hall and the Building Inspector then makes a site visit to the property to inspect the proposed project. When the proposed activity is planned for one of Monroe's historic landmark buildings or is located within one of Monroe's historic districts, the applicant is required to obtain a "certificate of appropriateness." This certificate is necessary if the proposed work will result in any "material change in the appearance of such historic property, or of a structure, site, or work of art within such historic district."

The application should be accompanied by drawings, sketches, photographs, specifications, descriptions, etc. of the proposed project. Typical illustrations an applicant should submit include such items as (1) photographs that show the existing conditions of the property; (2) a plan view map of the property, showing existing buildings, roads and walkways, and the location and design of the proposed improvements; (3) elevations of important facades, which illustrate how the finished design will look in relation to the existing building; and/or (4) construction details, such as the design of fencing. For new construction, architectural floor plans and elevations or a model of the proposed building as well as photographs of the neighborhood would illustrate how a new building would relate to adjacent structures. The Commission will only review exterior changes proposed for a structure and will not consider any interior alterations. The Commission is solely concerned with physical characteristics of the proposal. Although the Commission will not consider the use of the building as a part of the evaluation criteria, use many times has a direct impact on the exterior appearance of a structure.

A hearing date will be set for the applicant to make a formal presentation to the Commission. At least seven days prior to this review, the Commission is responsible for notifying "owners of any property likely to be affected" by the proposal. Sometimes the Commission "may deem it necessary to hold a public hearing."

At the meeting, the applicant or an agent of the applicant presents the project to the Commission. Within 45 days after the filing of the application, the Commission is required to issue a decision. This time limit can be extended by mutual agreement between the applicant and the Commission. If approved, the Secretary for the Commission transmits a Certificate of Appropriateness in letter form to the applicant describing the nature of the work which has been approved and a placard Certificate of Appropriateness to be displayed on the project. This information is forwarded to the Building Inspector and the building permit issued. If an application is denied, written reasons for the denial are mailed to the applicant. If an applicant is not satisfied, with the ruling of the Commission, an appeal can be made to the Mayor and City Council.

In cases involving demolition, the Commission must grant a demolition permit after reviewing the plans for the building that would replace the structure. If the Commission fails to approve the demolition request, the owner can have such building demolished, provided that a six month notice is given for the proposed demolition of a historic building. If the Commission approves the demolition, the activity can be carried out immediately.

6.0 Tools for Historic Preservation

"It is better to preserve than to repair, better to repair than to restore, better to restore than to reconstruct." A. N. Didron, 1839

6.1 Standards

It is important to know what the ground rules are when applying to the Commission for a "certificate of appropriateness." There are a 10 basic standards to consider in a preservation project. These guidelines encourage sound preservation principles. The basis for these criterion is the Secretary of Interior's Standards for Rehabilitation. These standards provide the framework for the specific guidelines developed in this publication and are described below with examples provided.

- (1) It is important to find a compatible use for a property. The use should require a minimum amount of alteration to the structure or a site. A local example is the reuse of the original post office, which was adapted for use as a library. The exterior of the structure remained intact in the conversion and important interior details were saved. A new use is likely for this structure, following the move to the new library. Ideally the new use will be carried out in a manner that is sensitive to the historic qualities of this building.
- (2) Important original elements, historic materials, or distinctive architectural features of a property should be retained.
- (3) Alterations to a property that seek an appearance earlier than the age of the structure are discouraged. As an example, colonial storefront would not be an appropriate addition to a turn-of-the-century commercial building.
- (4) Changes that have been made to a property within its historic period, defined as prior to the last 50 years, should be recognized as important and retained. If a back room was added to a 1900 commercial structure in 1920, the addition should be considered as historic in itself and as a part of the building's evolution.
- (5) Stylistic features of a property should be respected and retained. The characteristics that make up a typical Greek Revival house, such as giant columns, a central hall plan, a set-back from the road, and rectangular transom and sidelights around the door, should be retained.
- (6) The preservation axiom "preserve rather than repair, repair rather than replace, and if replacement is necessary duplicate the missing feature" holds true in all preservation projects. In summary, "if it ain't broke, don't fix it!"
- (7) Cleaning of buildings should be accomplished with the gentlest means possible. Sandblasting is a no, no.
- (8) Archaeological resources or potential archaeological resources associated with a property or adjacent to a property should be protected. A yard or garden on the property of an historic structure to be preserved should be respected and protected as well as the building itself.
- (9) An addition to a historic property or an alteration that does not destroy the historic materials should be carried out in a contemporary design that is compatible with the existing property or neighborhood in color, scale, material, and character. Additions should not try to imitate but make a contemporary architectural statement while respecting the original building.
- (10) Additions should be added in a manner that makes future removal easy.

6.2 Methods

There are several methods that can be utilized in accomplishing a historic preservation project. The condition of the property, degree of authenticity desired, and the funds available usually dictate the method used. Although words like "rehabilitation" and "restoration" might sound alike to many people, the end result of each activity is very different. It is important when planning a preservation project, that the appropriate method is selected. The various types of methods to consider are described below:

Reconstruction-	Reproducing , by new construction, the exact form and detail of a vanished building, or part of it, to its original appearance or its appearance at a certain time period.
Rehabilitation-	Returning a building or property to a state of utility while also keeping those parts of it which represent its historical, architectural or cultural significance. This is often called "adaptive reuse." Most of the construction projects carried out in Monroe will utilize this method of preservation.
Restoration-	Removing or replacing later work on a building to make it appear as it did originally or at a certain period of time.
Stablization-	Maintaining a building as it exists today by making it weather resistant and structurally safe.

6.3 Approach

After understanding the criteria of evaluation for preservation projects and the various methods of construction available, it is important to follow a logical progression in completing a project. The whole process should be a series of building blocks with each activity serving as a foundation for the next step. The steps to follow are listed below:

- (1) Inspect the Building - Before any preservation work is begun, an inspection of the property is essential. This step familiarizes you with the special problems and features of the building and landscape with which you are dealing.
- (2) Develop a master plan, related to the series of steps described below. This plan should be your guide for completing the project and can be designed into phases. This plan should develop a basis concept that will guide the total effort. In this exercise, it is important to be aware of the "reasons" of why things have changed in a structure. Former residents probably had a reason for making the changes and identifying those reasons assists you in understanding your building at a more indepth level.

In developing this plan, you will identify whether outside assistance is needed from architects, landscape architects, interior designers, and/or preservation planners. Before beginning any work, it is wise to document the existing condition of the building through photographs and notes. This information will not only prove interesting at the end of a project as a comparison of the work accomplished, but will also be necessary if tax credits are ever sought for commercial rehabilitation projects.

(3) Stabilize the building, if necessary - Stabilize the building to stop further damage, such as sealing a leaking roof. Through inspection it is possible to determine whether to use temporary or permanent means to stabilize a property. If a new roof is not economical feasible, patching the existing roof will stabilize the building until a more permanent measure can be taken. Temporary repairs should always be reversible and not harm the historic materials of a building. It is important in this stage to get the basic systems intact and to consider energy conservation methods.

(4) Protect the building from deterioration - This step is started when a property is stabilized. After this initial process, it is important to maintain the property against ongoing and potential property damage or personal injury.

(5) Accomplish any necessary structural repairs - Structural repairs are high on the list of priorities because they represents a relatively major cost and is vital to the overall condition of the structure. It also requires that conditions be open and quite often affects more than just the immediate area of work. It is not recommended that structural work be done in phases.

(6) Fix the infrastructure of the house - Because the mechanical systems, such as plumbing, heating, electrical and cooling systems, are central to the comfort and usefulness of a house or commercial building, these should be fixed or new ones installed early in the preservation schedule. Also, systems repair or replacement are expensive items which should be budgeted for early in the project. As with structural repairs, it is best not to work on mechanical systems in phases.

(7) Retrofit the structure for improved energy conservation - To insure comfort in the structure during cold winters and hot summers, energy retrofitting measures should be considered. These include caulking the exterior, particularly around doors and windows; weatherstripping around windows; installing storm windows and doors and insulation; and treating the foundations.

(8) Carry out cosmetic work last - Cosmetic work such as painting the exterior, repairing the siding, or reconstructing a porch should be the final step in a preservation project. It is important to save cosmetic work until last because it can be ruined or may have to be changed after primary preservation work has been completed. Cosmetic work will have the greatest visual impact to the structure. Homeowners are sometimes surprised to find that after years of carrying out the basic, but expensive initial first steps, the painting of an exterior or the repair of former details will generate the most public interest in the project.

7.0 Guidelines for Rehabilitation

7.1 Commercial Rehabilitation Guidelines

A. Adaptive Use - In the commercial district, the typical structure is a two-story, brick building with a storefront on the ground floor containing a large display window. The second floor is more enclosed with smaller windows on the front facade and was typically used for living, office, or storage space. It is important to find a use that retains the open storefront on the ground floor and to use the upper floor for a variety of compatible uses, such as offices or living quarters.

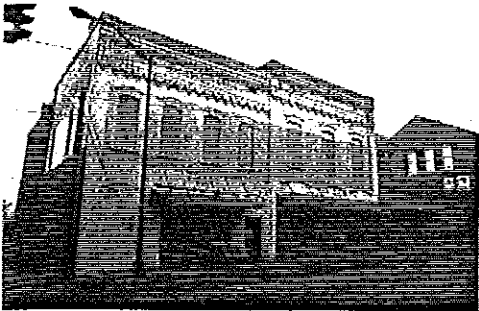

A typical commercial building in Monroe's central business district. These buildings are characterized by an enclosed upper floor and an open ground floor



A use for the hotel might include a retail use for the ground floor and office space for the upper floors.



Public buildings, such as the library, and other district landmarks, require uses that preserve the exterior appearance and important interior finishes such as the marble wainscoting in the library. For example, the library could be used for a chamber of commerce.

B. Commercial Facade Preservation - It is important in rehabilitation efforts that original elements of the commercial building, the storefront, the upper floor, and the details that distinguish each style, be retained. Intact commercial facades and storefronts should be rehabilitated using existing original materials. The design and reconstruction of a missing storefront or missing elements should be based on historical, pictorial, or physical documentation. A new design for a missing storefront on a commercial building should be compatible with the size, scale, material, and color of the historic building when documentation is unavailable.



Detailing in tin is a unique aspect of downtown Monroe and should be preserved.

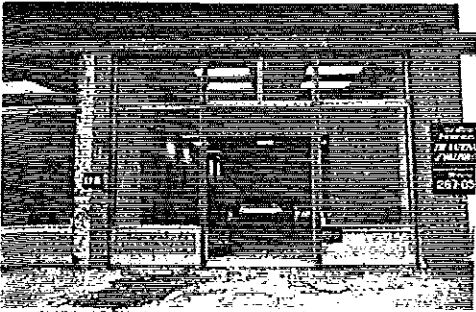

An example of original storefront rebuilt after a fire in a design reminiscent of historic storefront design.

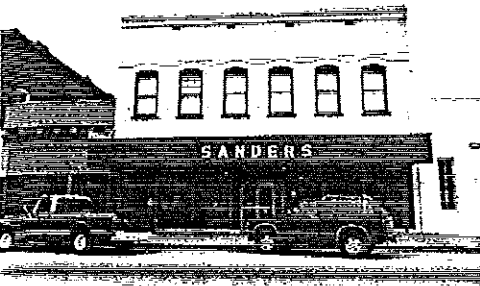

An example of a lack of attention to historic details. There is no uniformity in the upper story windows in this building. Attention to these details is what provides quality and physical integrity to a downtown district.



A commercial building should be treated as a whole, although there may be more than one business or office utilizing it. A uniform storefront treatment and color is advisable. This building has been treated in different ways and has a disjointed appearance.

C. Evolution of Storefront Design - As commercial architectural styles have changed, storefront design has evolved. Many times these changes have resulted in alterations to existing storefronts. Many of these changes are worthy of preservation as excellent examples of later architectural styles and trends. If the alterations are of quality workmanship and add visual interest to the building and district, they are valuable and should be preserved. Changes that are thematic in nature or relate to an earlier historical period should be avoided.

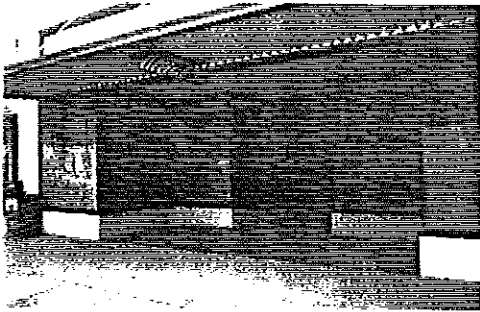

A typical storefront entrance design of the 1950's which illustrates good craftsmanship and an interesting appearance is worthy of preservation.

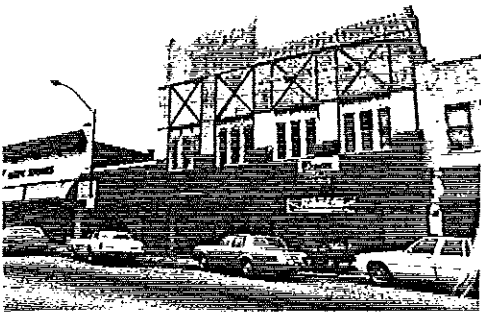

An example of a thematic alteration which is not appropriate on this early 20th century building.

D. Masonry - The large number of brick buildings in this district necessitates special care in masonry repair and sensitive cleaning, which means No sandblasting. The correct procedure is to remove deteriorated mortar by carefully hand-raking the joints to avoid damaging the masonry; duplicating the old mortar in strength, composition, color, and texture; and repointing by duplicating the old mortar joints in width and in joint profile.

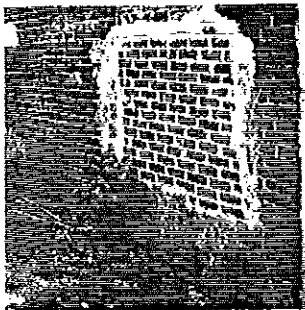

An example of improper masonry repair.

E. Awnings - Canvas awnings used in an historic commercial district can be an attractive, economical, and a practical addition to the character of the area. Awnings help to control heat loss and can also be used as an attractive sign surface. Colored awnings soften the hard lines of brick commercial buildings and add visual interest to the street. Metal awnings are discouraged as they do not provide flexibility in heating and cooling, and often reinforce a building's angular hard image. Standard, concave, circular, accordion and box style awnings are all appropriate to downtown businesses. New awnings should respect the "line" established by other awnings in the area.

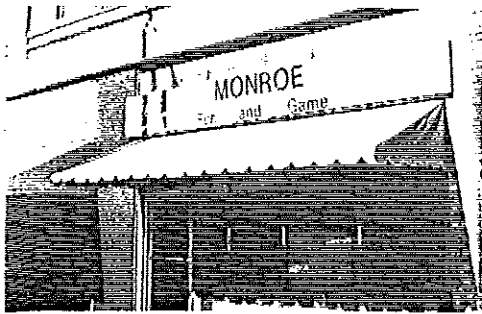

The only example of a canvas awning found in Monroe's central business district.

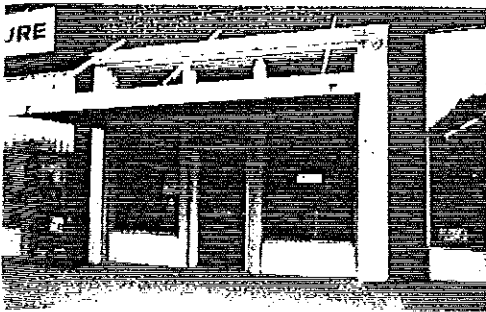

A metal awning which adds a harsh quality to this downtown storefront.



Metal awnings hide the important details associated with historic storefront design.

F. Doors and Windows - Every attempt should be made to retain original doors and windows. The addition of aluminum doors and windows is often necessary in commercial districts for security reasons, but can detract from the historic character of the storefront. However, the harsh effect can be softened by painting the aluminum a compatible color.



An example of aluminum doors and windows which have been painted a compatible color to keep the historic character of the storefront in tact.

G. Rear Entrances - The availability of parking lots at the rear of the commercial buildings in Monroe makes it important that rear entrances be developed for ease of access. An aesthetic design for a rear facade will also be a visual enhancement to the community.



An example of a rear entrance which has been improved to allow more convenient access and also enhance the appearance of the community.

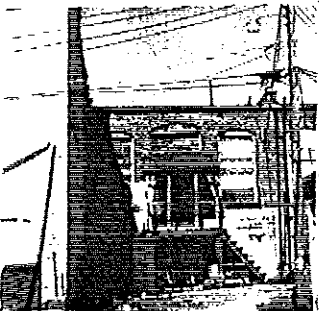

An example of a rear entrance which has been neglected.

H. Health and Safety Code Compliance - Compliance with health and safety codes and handicapped access requirements should be carried out in such a manner that preserves a historic building's character-defining spaces and preserves exterior features and finishes.

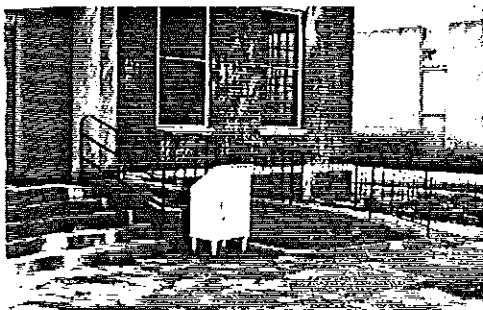

The location of a handicap access ramp on the front facade of the former library building is a visual distraction and would be more suited on a rear facade.

7.2 Residential Rehabilitation Guidelines

A. Adaptive Use - The residential districts in Monroe contain a significant collection of historic residential and institutional architecture. Adaptive use projects in these districts should insure that the exteriors of these fine structures are preserved and the single-family quality of the neighborhoods retained. The present use of some of these former residences for offices is an example of a compatible use. Other uses, associated with the tourism industry - restaurants, bed and breakfast inns, house museums - are examples of compatible uses that also can provide an economic benefit to the community.

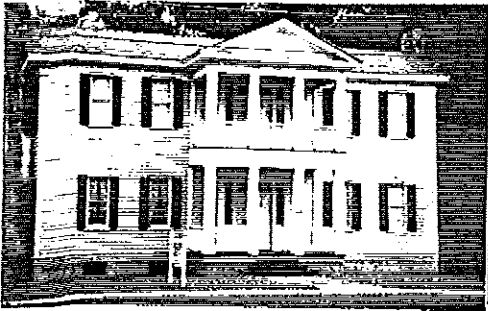

The Davis-Edward House is an example of a house museum which also serves as a professional office. The House is the headquarters for the Walton County Historical Society and a property worthy of development as a stop for tourists.



The numerous large, under-utilized historic dwellings throughout the community are potential candidates for bed and breakfast inn conversions. The limited amount of local hotel accommodations creates a demand for this type use, which can also be combined with an office use in part of the structure or the owner/manager might also reside in the house.

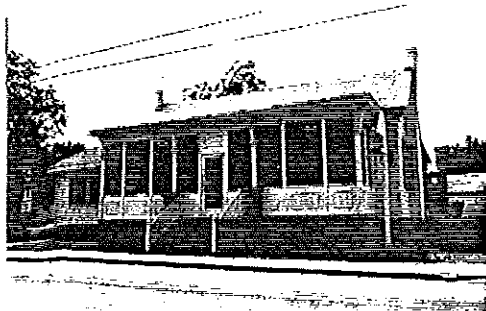

Malinda's Restaurant, recognized locally as one of Monroe's oldest dwellings, remains a living part of the community through an adaptive use as a restaurant.

B. Foundations - The original treatment of foundations in Monroe's residential areas was primarily open. Open foundations are created through houses set on masonry piers. Enclosure of these open foundations is recognized as an activity that assists in insulating the structure. Enclosing the foundation should be carried out in a manner which preserves the original pier. Both goals - energy conservation and preservation of the historic character - can be realized by recessing the added material or at a minimum creating a visual delineation between the original pier and new material.

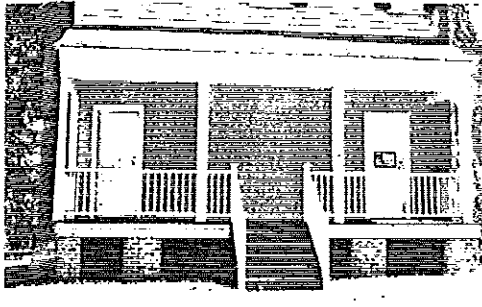

An example of retained piers with no visible enclosure. This is the optimum desired affect of residential foundations.

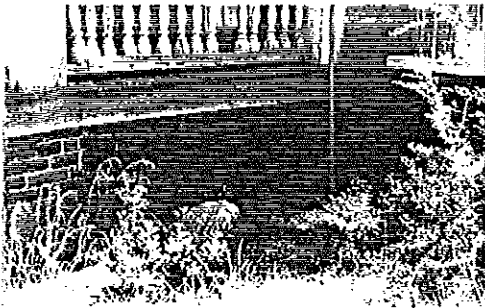

An example of recessed brick infill with the retention of the pier effect. This is a favorable enclosure treatment.



Examples of block infill with vents. This does not preserve the original pier affect because there is no recession of the blocks or delineation between the materials. The result is a heavy looking base which changes the character of the house.

C. The Porch - The porch is a common element in Monroe's residential districts. Enclosing the porch should be handled in a manner which preserves its open character and the original materials. Preservation of the open character is accomplished through the use of transparent materials, such as wire mesh and glass. The spaces created through the addition of screen supports should relate to the overall lines of the structure. It is also important in maintaining the original character of the porch to use compatible or original materials when replacing deteriorated porch posts, railing, and flooring.



An example of a porch enclosure which has preserved original materials and maintained the open character of the porch space through the use of screening. Equal divisions have been created by the addition of vertical and horizontal supports which relate to the lines of the house.



Although this enclosure partially utilizes screening, it also consists of solid material and inappropriate windows. The historical character of the house has been lost as well as the open character of the original porch space.



This enclosure results in concealing the original front porch and is discouraged. The new solid base causes a loss in the former open character of the porch space.

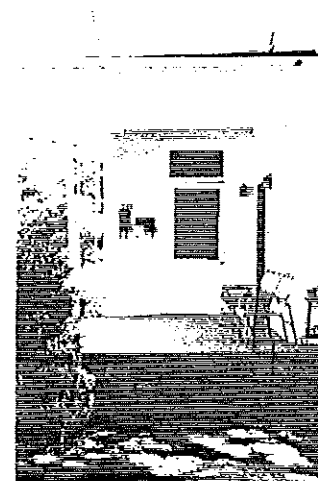

An example of a porch floor which was originally wood and has been replaced with cement. The result is one which is not compatible with the rest of the porch.

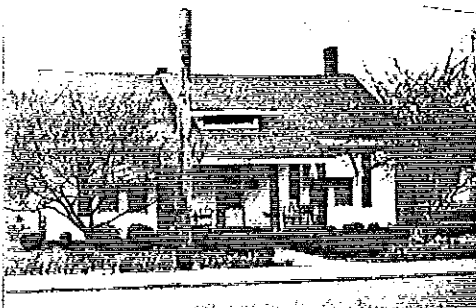

The replacement of porch posts with manufactured iron posts contrasts with the original wood posts of the structure.

D. Details - An important aspect of any preservation project is the retention of original details. Application of details which are not compatible with the historic and architectural character of houses should be avoided.



An example of applied shutters which are not appropriate to this house.

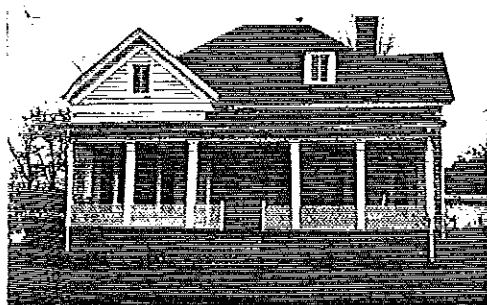

The lattice work on this porch is not fitting with this house and is not properly applied as porch railing material.

E. Black Resources - Historic resources associated with the black community in Monroe are particularly important due to their small number. These resources, which reflect an important part of Monroe's heritage as well as a cultural heritage of a broader scope, should be preserved.



Structures, such as these on the outskirts of the McDaniel Street district are examples of black historic resources that should be priorities for preservation.

F. Energy Retrofitting - Energy retrofitting measures should be carried out with particular care to insure that a building's windows and doors are respected. The use of reflective glass is discouraged. Storm windows and doors should be tight-fitting and the trim painted to match the historic frame. Storm windows might also be placed on the interior to minimize the change in appearance. Weatherstripping of windows is an inexpensive and excellent energy saving measure.

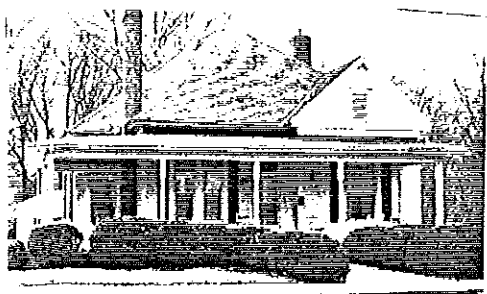

Storm windows and doors should be installed in a manner that does not obscure the windows and door frames. In this example, the original windows are still visible through the new replacements. Painted the window molding to match the house trim would also be desirable.

G. Siding - Wood frame structures in Monroe's residential districts play an important role in establishing the character of the district. Preservation of wood siding is recommended. The use of aluminum or vinyl siding is discouraged, since it can obscure historic detailing and alter the overall texture, form, and profile of a structure. If deterioration requires that new siding be installed, it should respect the historic proportions of the structure by duplicating the width of the original weatherboards; not obscure historic details, such as window and door moldings and pilasters; and not introduce nonhistoric textures, such as wood graining.



Example of vinyl siding applied to a historic residence which obscures the original details. These details are now flush against the vinyl siding and no relief is evident. Proper use of vinyl siding applied to an historic residence does not obscure the original details and duplicates the original width of the weatherboard.



The addition of asbestos shingles is also discouraged, since it changes the appearance of an original dwelling sheathed in clapboard.

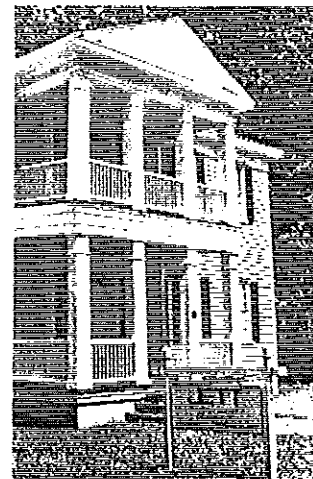

An example of well-preserved wood siding on the Monroe Historical Society office. All architectural details remain intact and by preserving the existing siding, the historic character of the structure has been retained.

H. Roof - Roofs play an important part in defining the character within Monroe's residential districts. Most roof material in these districts is composition shingle on single and multi-gabled roofs. In most cases, original roofing material has been replaced. The shape of the roof and roofing material should be respected in rehabilitation work.

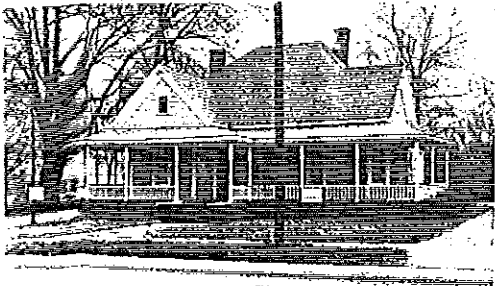

An example of original pressed metal shingle roof with standing seam metal on porches. The retention of these details keeps the character of the house intact.

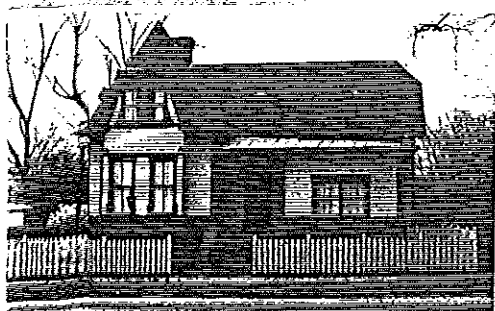

There was no attempt to match the new roof shape and materials with the original and the result is a destruction of the physical integrity of this house.



An example of total roof replacement with asbestos shingles. This is a typical replacement material in Monroe. It is important that the shingle color be compatible to the house.

I. Additions - Additions should respect the character and integrity of historic homes and be compatible to the original building. Attempts to make additions look as though they are original to the structure are discouraged. Additions should be unobtrusive and in proportion to the original structure. Additions on facades not visible from the public right-of-way assists in preserving the historic character of residential neighborhoods.



Compatible addition is at the rear of the structure (away from public view), in proportion with original structure, and materials similar to the original structure.



An example of an addition which alters the form of the historic structure on its street facade.

J. Gutters and Downspouts - Gutters and downspouts are important functional elements of an historic building. Gutters and downspouts should be designed to carry the volume of roof runoff and kept free of debris. From a visual perspective, gutters should follow the cornice lines of the house and be of a compatible color to the structure. Downspouts placed in nonobtrusive locations, such as along porch posts or at the corners of the structure.



The built-in box gutter located along the porch cornice of this structure is a typical type found in the district.

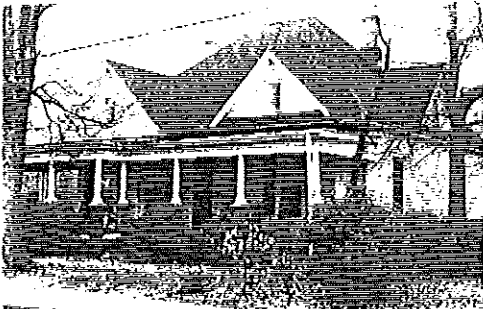

The hanging gutter located along the porch roof of this structure is a compatible color. Note the downspout location along the porch post.



The hanging gutter illustrated has an abrupt break which is a visual intrusion to the otherwise fine lines of this structure.

K. Garages and Outbuildings - Though many outbuildings are original to their historic residences, the majority of residential outbuildings and garages in Monroe are additions. Outbuildings should complement the historic dwelling through the use of similar or identical material, mass, color and scale. The placement of outbuildings and garages, typically in the rear yard, should be done in a manner which does not detract from the character of the original structure.

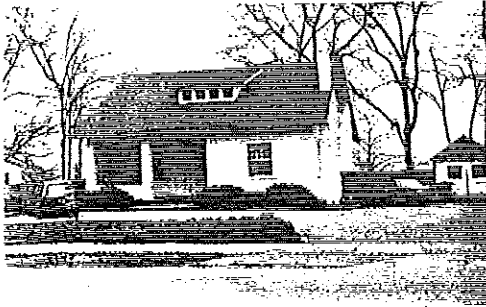

An example of an outbuilding of compatible design to the house. It has the same window proportions and Craftsman inspired style. It is also placed so that it does not interfere with the integrity of the house.

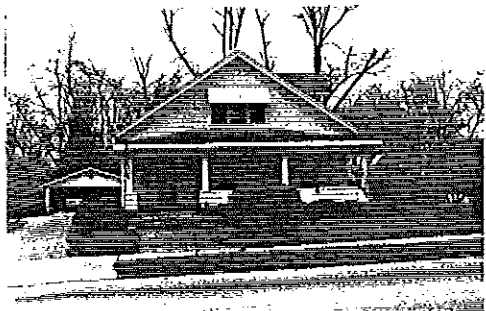

An example of a garage of compatible form and scale to the residence. The gable orientation of the garage repeats the gable form of the house. The materials used in the garage are also compatible. The house receives visual attention instead of the garage.

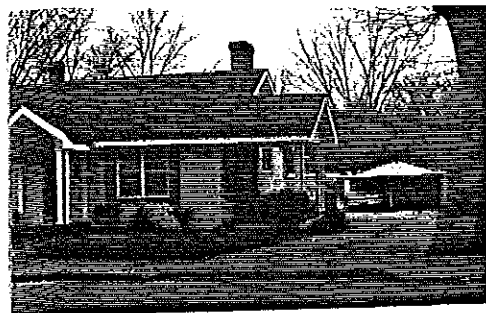

An example of a garage which is not compatible with the original structure. It has no relation to the style or roof form of the house.

7.3 Mill Village Rehabilitation Guidelines

A. Adaptive Use - The mill district was planned as a self-sufficient community with a variety of building types serving different functions in the activities of the residents - such as places for work, play, worship, study, shopping, and living. It is important to preserve this type mix and the original exterior appearance of the buildings as they are adaptively reused.

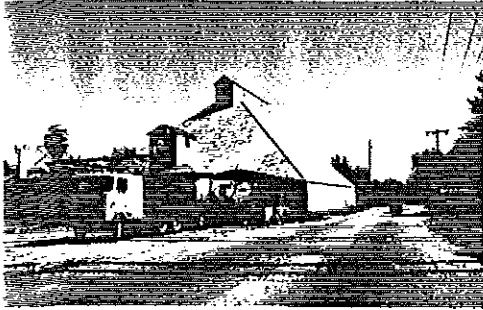

The industrial buildings are the keystone of the mill village complex and should be preserved. A continuation of the original use is the most desirable. In adaptive uses situations, new uses should be found which preserve the original exterior appearance of the buildings.



Support buildings within the mill village complex include churches, a school, community center, and a variety of store buildings. Uses should be found to preserve the numerous corner stores within the village.



The majority of the buildings in the mill district are single family or duplex family modest frame dwellings. A continuation of the original use or a use which preserves the residential character of these dwellings is desirable.

B. The Front Porch - The open front porch is a common element on houses throughout the district. Porches were typically raised with wood flooring, simple wood railings and posts, and modest detailing, such as sawtooth trim and exposed rafter ends. The plain style detailing, open character and predominant use of wood should be retained on porches within the mill district.



Rows of open front porches are a commonplace element in the district.

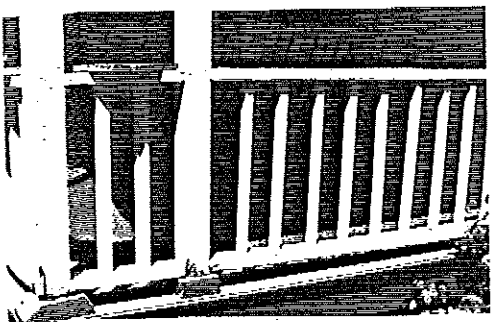

Porches are characterized by wood railings and posts of simple design, such as the simple pickets pictured here. This porch has retained its original wood railing and posts. Any replacement members should be identical in the size, shape, and detailing of this original railing.

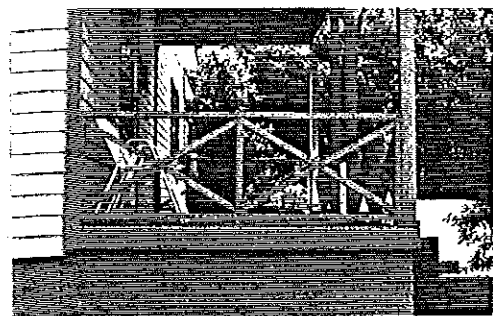

Porches in the mill district are also characterized by simple 2" x 4" wood members joined to form "X's."



The addition of lattice is out of character with the more modest porch detailing found on structures throughout the district.



An example of manufactured iron porch supports used to replace original wooden supports. The material and detailing of the replacements is unlike the original wooden posts and contrasts with the simple qualities of the dwelling.

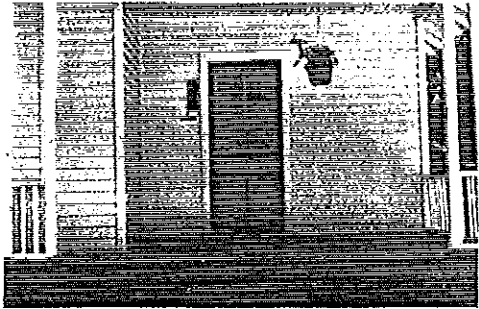

An example of wood flooring as an original element of the front porch.

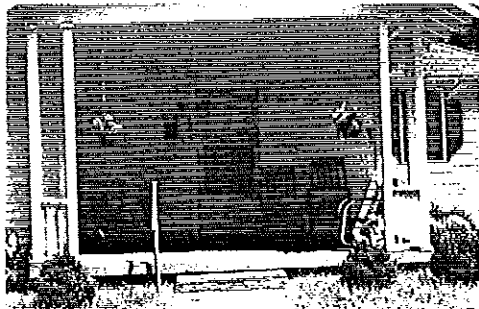

The replacement of the wooden planked porch with concrete creates a heavy appearance and is discouraged.



An example of an open porch later screened in. Although transparent screening material has been used, the added solid base makes this porch bottom-heavy and alters the open character of the original porch.

C. Wood Siding - The Monroe and Walton Mills Historic District is characterized by wood dwellings. Preservation of wood siding is recommended. The use of aluminum or vinyl siding is discouraged, since it can obscure historic detailing and alter the overall texture, form, and profile of a structure. If deterioration requires that new siding be installed, it should respect the historic proportions of the structure by duplicating the width of the original weatherboards; not obscure historic details, such as window and door moldings and pilasters; and not introduce nonhistoric textures, such as wood graining.

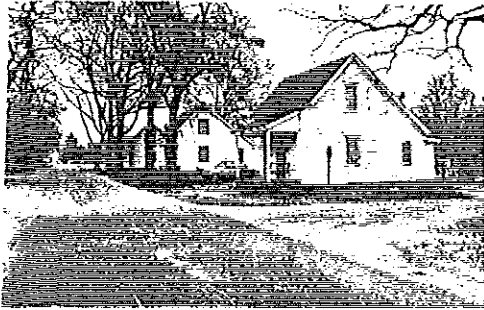

The use of wood plays an important role in defining the character of the mill district.

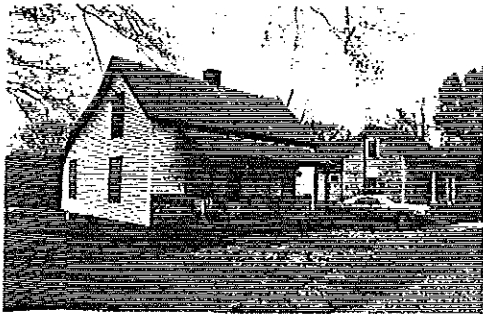

New vinyl siding and “fake brick” wainscoting alters the original appearance while original wood siding preserves the character of the dwelling.

D. Masonry - The mill district is also characterized by a variety of support buildings constructed of brick. Special care should be taken in masonry repair and cleaning. The correct procedure for masonry repair is to remove deteriorated mortar by carefully hand-raking the joints to avoid damaging the masonry; duplicating the old mortar in strength, composition, color, and texture; and repointing by duplicating the old mortar joints in width and in joint profile. Cleaning should be accomplished by the most gentle means possible. Sandblasting of masonry surfaces is not allowed.

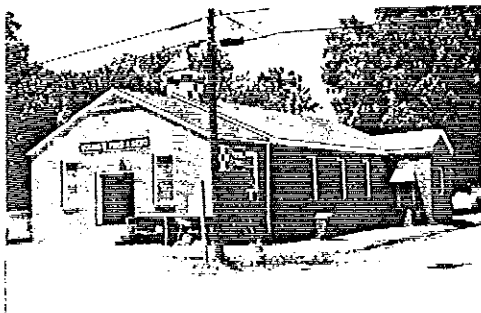

This brick building was originally a church which is obvious because its exterior shape and materials have been preserved.

E. Foundations - Most of the original open foundations of the mill village have been infilled with brick. This has created a uniform appearance throughout the district. Enclosure of the open foundation assists in insulating a structure, but should be carried out in manner that preserves the original pier effect.

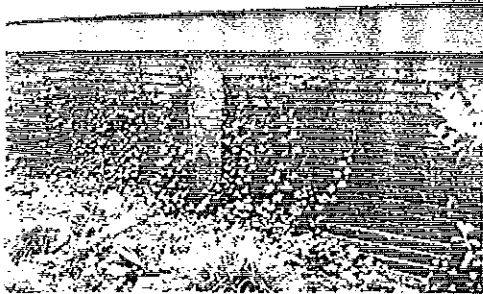

An example of the preservation of the pier effect through recessing the infill material.

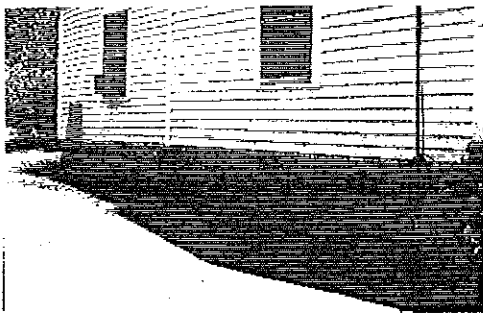

An example of a foundation which has been infilled but still retains the pier effect by utilizing pierced vents in the brick.

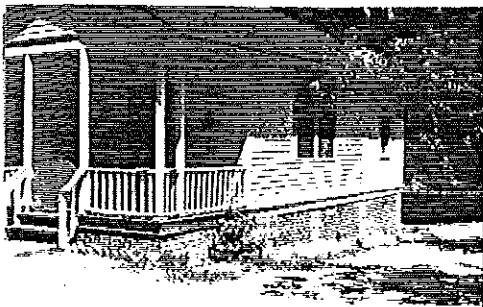

An example of a foundation that had brick piers and was later enclosed with brick infill. The infill is flush against the piers and the only trace of the original piers is the difference in brick color.

F. Energy Retrofitting - The addition of polyurethane sheets to windows and doors is a temporary weatherproofing measure that has little impact on a structure. Weatherstripping of windows is an excellent and inexpensive energy saving measure. More permanent techniques, such as the addition of storm windows and doors, should be applied in a manner that allows original doors and windows to remain visible. Storm windows might also be placed on the interior to minimize the change in appearance. The typical glaring character of storm windows can be softened by painting the aluminum trim the color of the historic frame.



The addition of polyurethane sheets to windows and doors of the dwelling in the foreground is a temporary method of weatherproofing a structure that does not harm the historic material.

8.0 Guidelines for Streetscape Improvements

8.1 Commercial Streetscape

A. The Sidewalk - The sidewalk surface in Monroe is comprised of a paved surface bordered on one side with curbing. The hexagonal paver is a common paving material in downtown Monroe. This feature should be preserved and where deteriorated, it should be replaced with a paver or paving pattern of similar design. The dominant streetscape layout of roadway, curbing and sidewalk should also be retained.

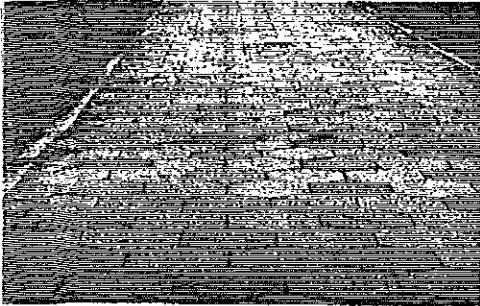

An example of walkway paved with hexagonal pavers leading to the courthouse steps.



An example of new, expansive, concrete paving which creates a glaring surface with little visual interest. An important element of the historic streetscape, the curbing, is missing in the new sidewalk.

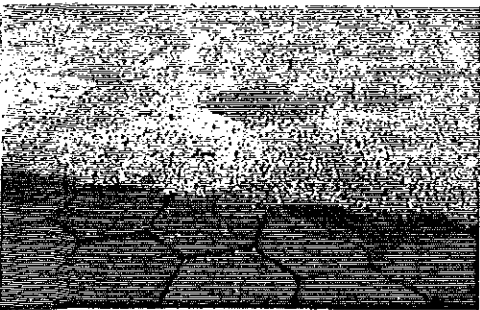

An example of poor workmanship where old and new paving abruptly meet each other.

B. Open Space - The most significant open space in Monroe's commercial district is the courthouse square with its tree-shaded lawn and confederate statue. This space should be preserved as a space for public enjoyment.

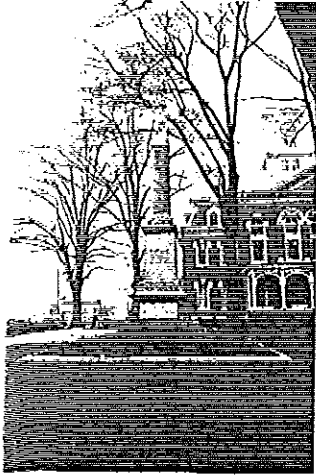

Photograph of courthouse square illustrating its park-like qualities - large shade trees, grassed lawn, and civic art.

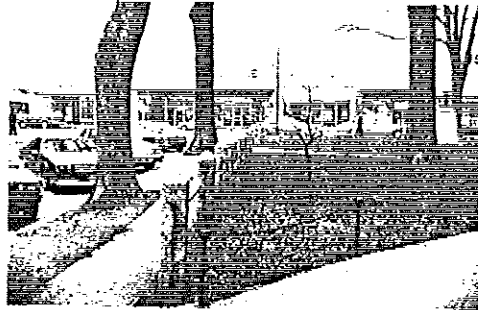

The barriers surrounding the square make it inaccessible to public use and limit the activities of the town center. As a park space, it should draw people downtown and be used as the site of local festivals.

C. Street Trees - Tree preservation is important, particularly in in a town such as Monroe which is full of beautiful, mature trees. Trees add to the historical character of the city and are of critical importance to a downtown area due to the majority of paved surfaces.



One of the communities most significant trees is the holly tree, situated in front of the Walton County Historical Society Headquarters. This tree is reputed to have been part of the virgin forest which formerly stood on the site of the town.



An example of trees along the commercial streetscape which are threatened by paving over the root system. Trees in an urban situation require a four

D. Signage - Signage should be subordinate to the architecture of the building and sized for legibility at a reasonable distance, particularly to pedestrians and motorists passing through the town center. Appropriate locations for signage set flush on a commercial building is the lintel space which separates the storefront from the upper floor and the space above the transom in the storefront. Some unique locations for signage includes the window or the entrance floor.

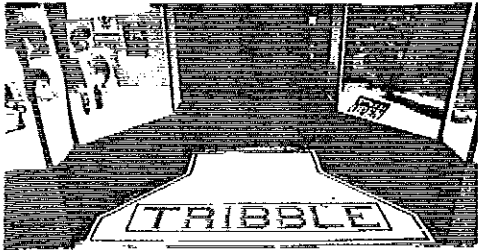

Taking advantage of the entrance floor space for pedestrian advertisement.



An example of window signage, primarily designed for the pedestrian.



The scale of this sign is too large for the building.

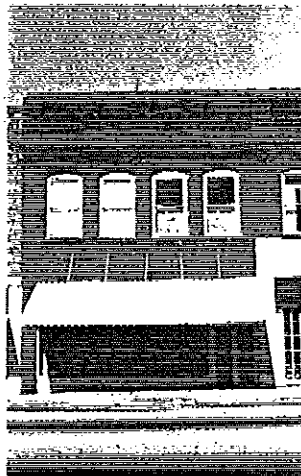

An example of potential sign locations - on the cornice of an historic building or in the space above the transom in a storefront.

E. Light Standards - The existing lighting in downtown Monroe is provided by a roadway luminaire, called a cobra head style fixture, situated on a decorative pole. The pole design blends with the historic town center, but the luminaire is a conflicting element.

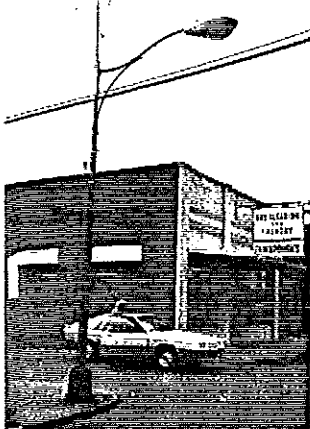

An example of the existing light fixture in downtown Monroe illustrating the compatible pole but incompatible luminaire.

8.2 Residential Streetscape

A. Landscape Design - Landscape design in Monroe's residential neighborhoods is composed of mature trees, shrub and ground cover plantings, grassed lawns that blend from one yard to the next, edged beds, and walkways. Most of the residential districts are characterized by informal landscape design with more formal design found in the North Broad Street district. The prevailing landscape character should be preserved. Necessary clearing of overgrown landscapes should be selective.



An example of an historic landscape treatment. Note the sawtooth edging, a typical landscape edging material from the historic period.

An example of overgrown vegetation which obscures the character of this Victorian era house. If selectively removed, the residence would be more visible.

B. Signage - Because adaptive use of homes in historic residential districts is encouraged, guidelines regarding proper signage for these businesses and offices is necessary. Signage should be subordinate to the architecture of the building and sized for legibility at a reasonable distance. An appropriate location for signage in residential areas is in the front yard where it does not distract from the architectural integrity of the house. The sign itself should be in proper proportion to the historic structure and not overwhelm it.



An example of signage on a former school structure that is out of scale with the neighborhood and building. A more appropriate location for the signage would be in the front yard along the street so that it is more visible to passers without distracting from the character of the building.



An example of favorable signage in a residential district. The sign does not detract from the house but yet it is plainly visible from the street. It is also in keeping with the streetscape and residential quality of the area.

C. Street Trees - Trees play an important role in creating a pleasant residential character in Monroe's neighborhoods. Trees are also important along major thoroughfares, since they help to create a positive first impression of the community to visitors. The mature trees should be retained through periodic pruning and the provision of adequate size planting beds. In most situations, the replacement of aging trees should duplicate original varieties.



The character of Monroe's residential streetscape is that of uniform setbacks, frame residences, and large hardwood street trees. The street trees assist in creating a livable residential environment.



Most historic districts in Monroe are lined with mature trees which give the city a pleasant and residential feeling. In many cases, the preservation of street trees will be a responsibility of the private homeowner since many trees are located in the front yards of dwellings adjacent to the street.



Trees along major roads, such as SR 11, are particularly important. Visitors receive their first impression of the city traveling this route and the trees favorably enhance the streetscape. Power lines along this road make the dogwood tree, which is a low growing variety, a better replacement selection than the taller oak trees.

D. Mechanical Systems - Mechanical systems, such as air conditioning and heating system units and electrical and gas meters, should be situated in non-obtrusive locations on a structure.



An example of an insensitive placement of an air conditioning unit in the window on the front facade of an historic structure.

E. Fences - Open fences are a common element in Monroe's residential districts. It is important to retain historic fences in Monroe's historic neighborhoods through periodic maintenance and the replacement of deteriorated parts. The design of a new fence should be compatible in shape, color, and mass to other fencing in the neighborhood and relate in design, color, and materials to its associated dwelling.

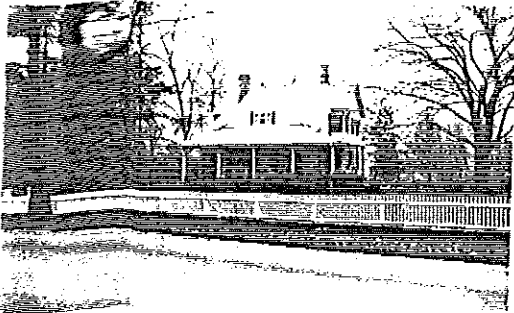

This picket fence is compatible to the material, mass, color and scale of this Victorian era house. It also preserves the open character of fencing of the area.

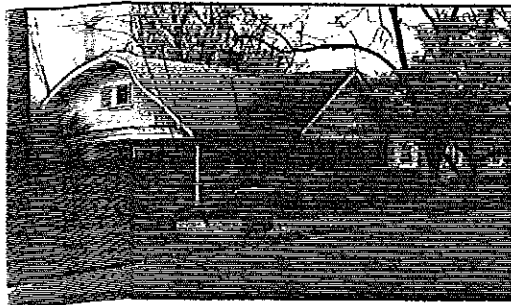

This fence retains an open character, popular in the fences of Monroe's residential districts. It is compatible in scale, color, and massing to the structure it surrounds.

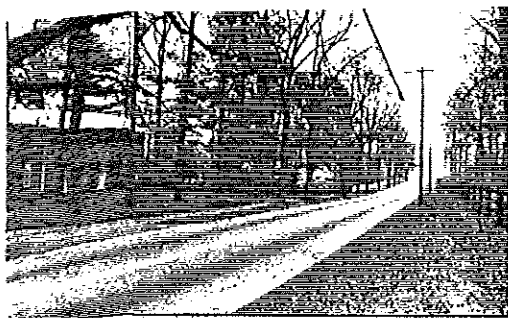

An example of the open character of fences in the McDaniels Street district. Both the iron and the wooden fence retain this character.

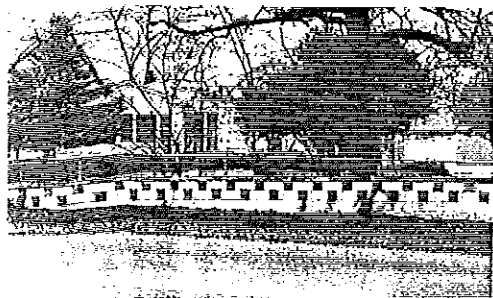

An example of a non-historic fence. The concrete block and chain link materials are not compatible with the original structure in shape, color, or massing and contrast with the frame character of the surrounding neighborhood.

F. Estate properties - Historic districts such as McDaniels Street, North Broad Street, and South Broad Street contain several estate properties. These properties typically include residences and outbuildings situated on large lots, sometimes several acres in size. These estates are representative of an historic way of life in Monroe and should be preserved. Redevelopment of these properties in the future should attempt to preserve the historic buildings and landscape elements. The building of additional structures on an estate site should follow new construction guidelines and be carried out in a manner that complements the existing historic setting.

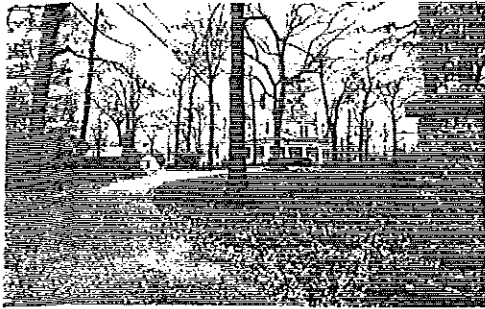

Redevelopment of the Walker-Field Estate should recognize the importance of the site's many landscape elements - the entrance drive, mature hardwood trees, hedgerows and walls.



The addition of new buildings to estate properties, such as the McDaniel-Tichenor House located in the McDaniels Street Historic, should recognize and respect the visual dominance of the residential structure.

8.3 Mill Village Streetscape

A. Streetscape Character- The streetscape character of the mill district is informal with little curbing or sidewalks. The most dominant landscape feature is the large oak trees. These trees should be preserved. Paving should be kept away from tree roots and replacement trees should be of identical varieties. If sidewalks and curbing are added they should be of an informal quality, such as rolled curbing.



An example of the informal landscape character that typifies the mill district.

9.0 Guidelines for New Construction

The purpose of the guidelines for new construction is to assist in the design and construction of a contemporary structure or structures on undeveloped or underdeveloped land in a historic district. These guidelines can also be appropriate in the design for significant exterior renovation of existing non-historic properties in these locations. It is important for the design of new buildings acknowledge the historic context within which they are to be located. In a district, often the historic significance is contained in the collective character of all the improvements; houses, commercial buildings, street and sidewalk improvements, etc. rather than the form, details, or materials of a specific building.

The design of new buildings, often called "infill development," should be influenced by the character of the district as well as be evaluated for their impact on the district. These considerations should include not only the building but also the site design and landscape treatment.

The following guidelines represent significant principles and other considerations which should be used in the design of and the review of designs for new buildings in historic districts. These guidelines are intended to support a creative design process for new buildings while insuring the historic resources of the community are preserved in the midst of progress.

9.1 Define the Area of Influence - The area of influence will vary for different locations in or adjacent to a historic district. This zone of influence is important to define at the outset to assure the proposed improvement gives appropriate consideration to the historic resources of the district. Three typical influence areas are presented below. Consideration should be given to the rear areas as well as the characteristics in front of and beside the proposed site.

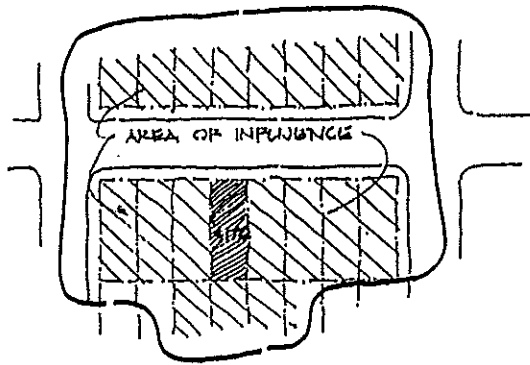

Interior Lot

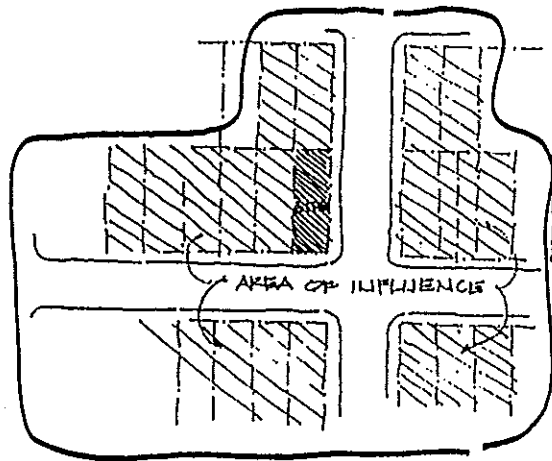

Corner Lot

9.2 Identify the Historic Context

Recognize and relate to the established configuration of lots and relationship of buildings to lot lines through orientation and setback.

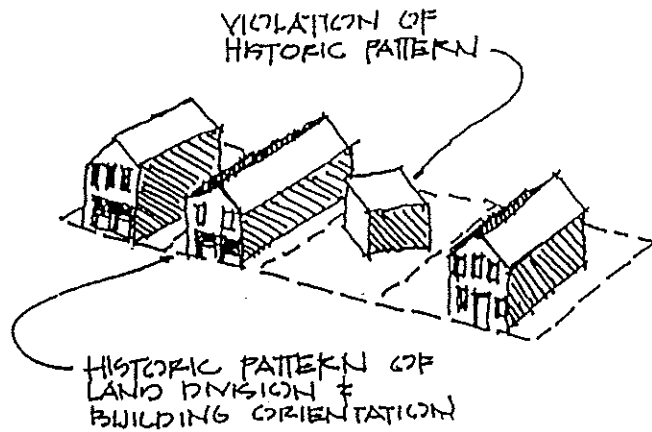

Recognize the historic attempts to control climate by architectural means such as awnings, overhangs, porches, and siting.



Recognize the relationship of facade elements to the scale of a person. - Identify the scale of doors, windows, overhangs, etc. of properties within the area of influence to scale of a person. Pursue the use of compatibly-scaled elements on the new construction project.

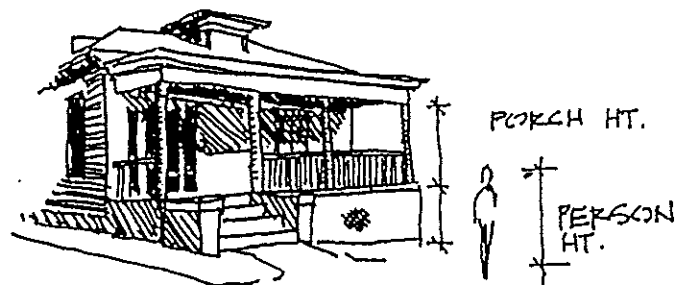

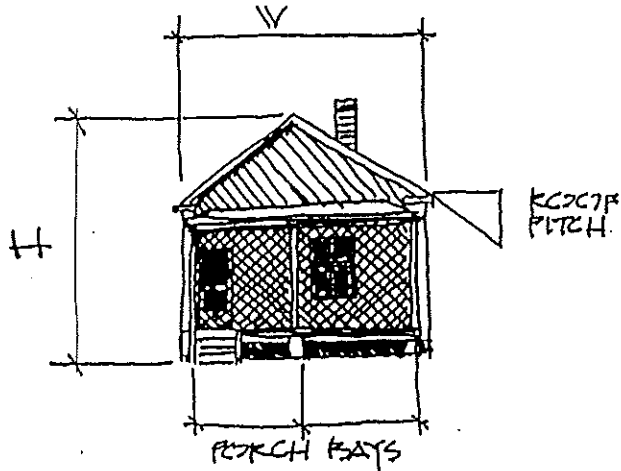

9.3 Recognize Basic Design Concepts

Proportion - Proportion is the ratio which relates the dimensions of elements of a building (height, width, window size, roof pitch, etc.) to the building as a whole and to each other.

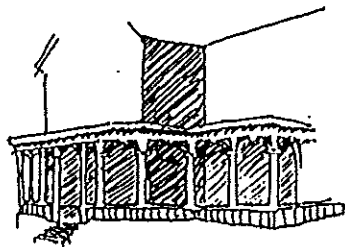

Pattern - Pattern is the arrangement of similar design elements in a regular and repetitive manner as an architectural expression. Patterns can be found in facades of individual buildings or in groups of buildings.

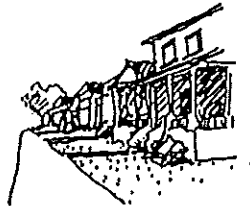
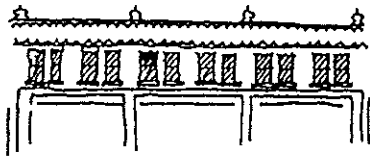

Mass, Height, and Form - An area of influence within a district has an established character of height, mass, and form. New development should respect and acknowledge the basic sizes and shapes of the surrounding buildings. The new building should express the prevailing building heights within a district, the prevailing scale and proportion of major facades, and the forms typically expressed in primary elevations.

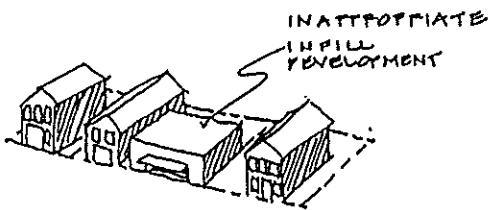

9.4 Incorporate Architectural Elements of Significance

Architectural elements which provide clues to the development of a respectful infill project are identified below. Each of these may be more applicable in one district or area of influence than in others.

New buildings should not attempt to create "a new historical work" but rather acknowledge the essence of the original work in a district in a contemporary design which uses or is compatible with and complements the original materials, proportions, scale, and detail within a district.

Roof Shapes, Appendages, Pitches, and Materials - There are a variety of roof shapes and types found within a historic district. Roof drainage systems and chimney forms also influence roof designs. The area of influence for each project will provide focus on this and other architectural characteristics.

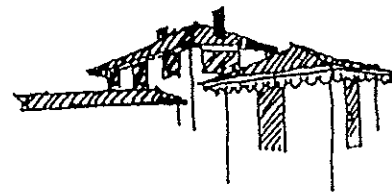
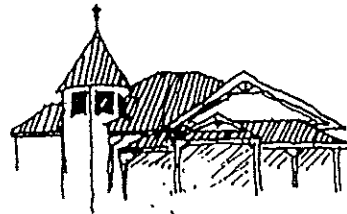

Walls and Porches - The area and orientation (vertical or horizontal) of walls is a significant design clue. The presence of porches has a distinct influence on the exterior character of walls. The presence of breaks or turns in walls reflects historic functions within a structure and can in a grouping represent a pattern which may deserve recognition in an infill design.



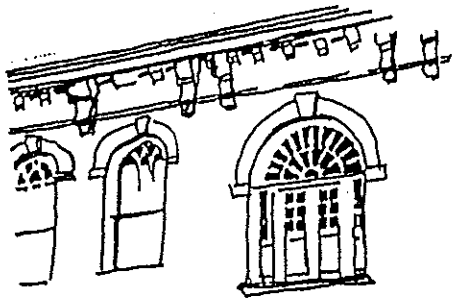

Windows - Windows are an essential element to the interior and exterior of a building. As a result the interior floor plan and light requirements should be established with an awareness of their impact on the exterior facade and the relationship of the resulting elevation of the surrounding area of influence within the historic district. Window size and divisions (lights) represent a pattern which can help integrate a new building into a historic district.

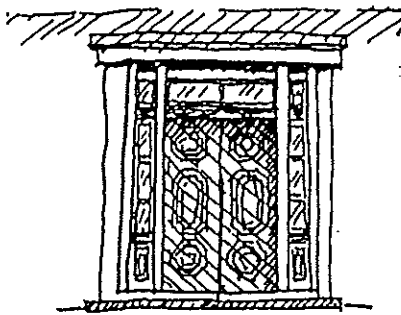
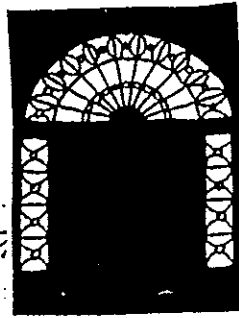

Doors - Door openings, including side lights and transoms, express the relative importance of the entry within an elevation. The placement of the door in relation to windows and the ground (at ground level or from a porch or stoop) and the detailing of the doorway can be important.

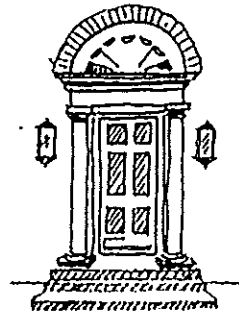

Materials - The materials in a new building should respect the prevailing materials in a district. Modern materials such as vinyl siding or dry-vit wallboard did not exist when the districts were developed. In addition they try to replicate historic materials, (lapped siding and stucco respectively), a difficult assignment. Traditional materials; brick, wood and stucco are preferred for infill projects. However, if the modern materials such as vinyl siding or dry-vit are selected, simulated patterns such as wood grain should be avoided. Attention to the quality of installation will also be important for these materials to be as unobtrusive as possible. Pay attention to trim work around corners, doors, windows, and other breaks in the material.

Details - Facia, soffit, eave, and cornice trim provide a pattern and scale to historic buildings. While a new building may not be able to and probably should not replicate historic trim and details, the pattern and forms of these buildings within a district can be included in a contemporary facade to create a link between the history and the present.

9.5 Implement Sensitive Site Improvements

Parking and Other Significant Site Features -

Parking is a contemporary site function which is often difficult to address in a historic district. Parking requirements should be tailored to meet the basic needs of the proposed use and respect and preserve the historic character of the district. Consider the availability of alternative transportation modes (walking to work, public transit, biking to work) and the potential for off site lots to meet facility needs beyond the basic requirements. Disperse parking into smaller areas to the greatest degree possible in an area out of prominent view.

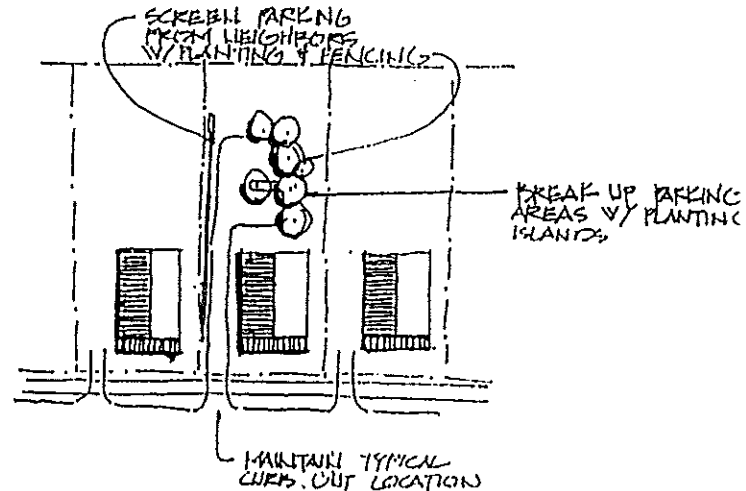

Walls and Fences - These site elements should be subordinate design elements to the architecture of the district. They should conform to any historic precedents for screening yards, parking areas or other private spaces. Materials should be traditional.

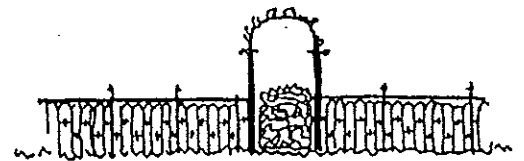
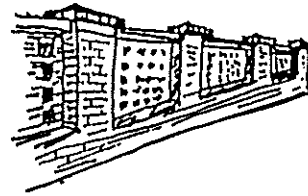

Mechanical Systems - The location and screening of mechanical equipment is another modern intrusion into a historic environment. These should be located out of sight and be screened with suitable fencing appropriate to the district and/or planting which respect historic planting relationships where applicable. The same principle applies to utility meters and trash containers.

Walks and Drives - The established pattern of walks and drives should be continued. New internal walks and drives should be subordinate to the primary pattern in the area of influence.

Signs - Signage should be subordinate to the architecture of the building and compatible with it. It should be sized to facilitate legibility within a reasonable distance rather than competition for prominence with adjacent signage. In residential districts or commercial areas which were originally residential in character, signage should be limited to small yard signs of uniform character.

SITE

Site features include driveways, walkways, lighting, fencing, benches, fountains, walls, terraces, plants & trees, outbuildings, signs, and drainage & irrigation ditches. If any of these need repair, it should be accomplished by utilizing the original material, where feasible. If substitute material is required the new material should match in color, texture, durability and scale.

WALKS AND DRIVES

Walks and drives should be proportional in size to the structure. Residential scale walkways are typically four to five feet wide. Commercial scale sidewalks found in downtown districts can range from eight to twelve feet in width, but in some communities may be even wider depending on the layout of the town.

Paving materials include dry laid or mortar set brick in a variety of brick paving patterns, often edged with cedar, brick, dirt or gravel. Concrete paving, and concrete pavers, usually in square, rectangular, hexagonal or octagonal shapes are also a common pedestrian paving surface. Concrete pavers were a popular sidewalk material used in downtown areas in the late 19th and early 20th century. Commercial sidewalks were typically edged with granite. Low retaining walls are typical for late 19th and early 20th century. Used extensively in residential zones, this treatment raises the front yard above public walkways.

Repairs to walkway surfaces usually involve the replacement of deteriorated concrete or replacing or relaying pavers that have cracked or shifted. Pavers that have shifted create an uneven walking surface and thus deserve prompt attention. A properly prepared foundation bed will minimize the potential of settling. It is often difficult to match existing concrete paving with a new concrete surface. Painting or more preferably, staining the two concrete

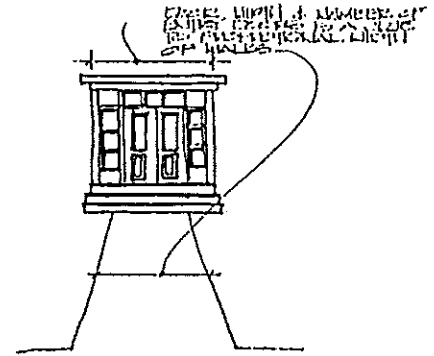

RESIDENTIAL WALKWAYS

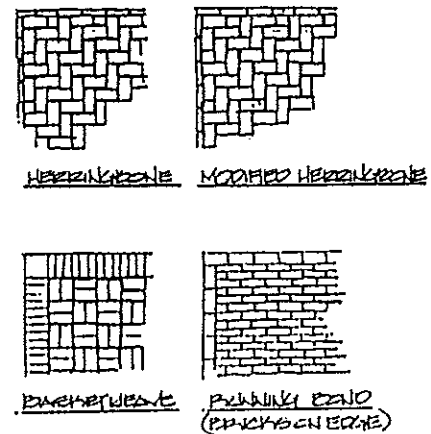

BRICK PAVING PATTERNS.

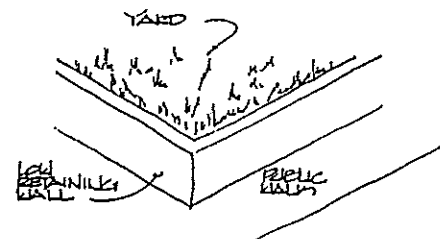

RAISED YARD

surfaces in an uniform color assists in blending the two areas. Concrete paving is typically four inches thick for walkways and six inches thick for drives with reinforcing screen placed approximately two inches from the bottom when considering a total replacement. Concrete pavers to match the historic hexagonals or octagons are still available. New interlocking concrete pavers can be a compatible substitute for traditional brick or pile cast concrete pavers.

EXTERIOR LIGHTING

The type of exterior lighting appropriate to a historic property depends on the type of preservation approach. A restoration project, for example, would require that lights which duplicated in style original historic fixtures be used. In contrast, contemporary fixtures compatible with the historic character of the structure would be more appropriate in a rehabilitation project. When using reproductive type fixtures, the style of the light should respect the architectural period of the structure. Many of the new reproduction type fixtures are not appropriate for private yard lights. Small unobtrusive footlights and concealed up lighting of trees and shrubs are adequate for lighting gardens and walkways.

In a commercial district, lighting is required for the vehicular lanes as well as the sidewalk. A sidewalk is most appropriately illuminated using pedestrian-scale lighting, usually in the 13 feet high range. Pedestrian lights are systematically spaced for even light distribution. Both contemporary fixtures that blend with the historic character of the downtown or reproductions of historic fixtures, called "period lights" can be suitable selections. Period lights typically feature metal shafts and stylized globes.

Vehicular lanes are typically illuminated by much

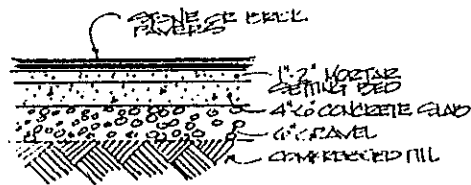

MORTAR SET PAVING



DRY-LAID PAVING

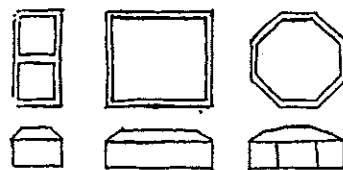

CONCRETE PAVERS



CONCEALED UP-LIGHTING

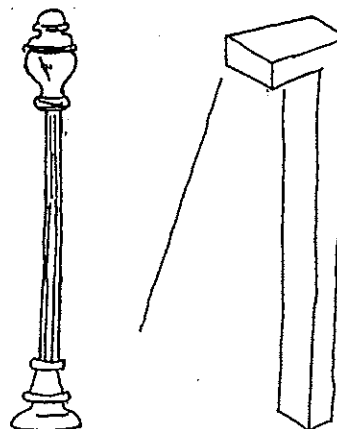

PERIOD REPRODUCTION

CONTEMPORARY SHOE BOX FIXTURE

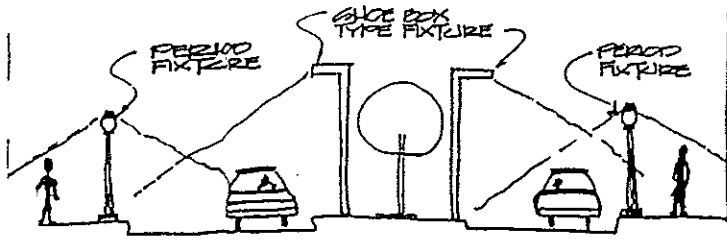

STREET AND SIDEWALK LIGHTING

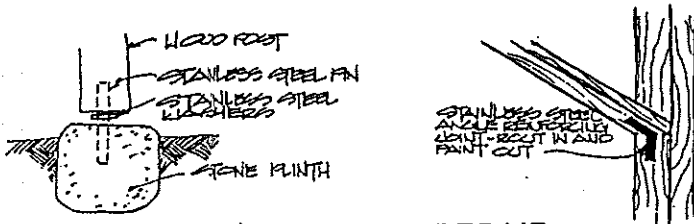

RESETTING FENCE POST

REPAIR SAGGING RAIL

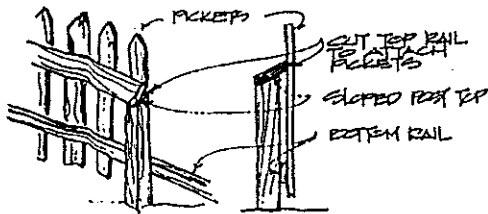

SLOPED RAIL DETAIL

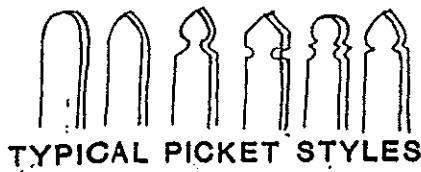

TYPICAL PICKET STYLES

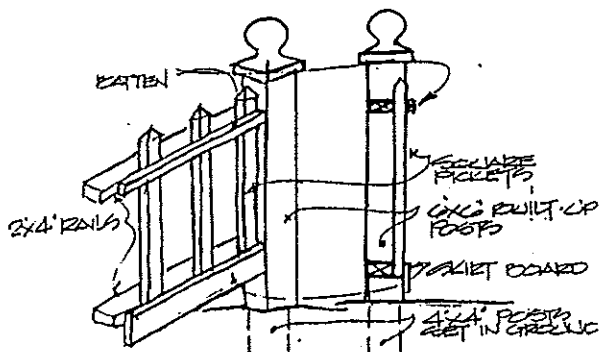

TYPICAL FENCE CONSTRUCTION

taller and more powerful light standards, called "roadway luminaires," usually over 30 feet in height. Contemporary design is best suited for these large scale lights. These lights should be placed in locations for maximum lighting output with a minimum visual impact on the historic district. In some historic commercial zones, existing roadway lights have been painted in an attempt to soften their presence.

Both contemporary and period exterior lights can be obtained with current technology efficiency using high pressure sodium, mercury vapor or metal halide.

FENCES

Fences found in historic districts are usually constructed of wood, brick, or iron. The wood picket fence is one of the most typical. The design of the picket should relate to the style of the structure. Pickets of the colonial era are simple, while pickets of the Victorian period are more fanciful and elaborate. Victorian pickets were shaped and fretted, sometimes resembling Gothic steeples or Italian bell towers. More rural examples often had posts with eaves to match the Gothic farmhouse they enclosed.

Because wood will rot, fences from time to time may need repair. Posts should be pressure treated and installed to minimize direct contact with the ground. Rails can be repaired by bracing with stainless steel angles. Contact lumber yard with a mill work shop to match fence elements which are no longer available as stock items.

Rotted and deteriorated pickets should be replaced. New pickets should be fabricated to match existing pickets from pressure treated stock. Ideally, pickets should be a minimum of two inches from the ground.

Cast iron fencing is typical of late 19th century. It offered flexibility in design and affordability, since it was poured into molds, allowing mass production of intricate designs, such as interlacing flowers and vines. Typical maintenance problems include rust removal, paint removal, and waxing for rich finish. Typical repairs might include the replacement of sections damaged by rust or the straightening of bent sections. Paint is best removed with a chemical paint remover, wire brush, and rags. Incorrect repairs can ruin fine ironwork permanently. It is important to always attempt to use the technique and pattern of the original ironworker. Cast iron does not lend itself easily to repair since it is brittle and often difficult to weld. Repair of cast iron is best accomplished in a workshop rather than the field.

The finish of ironwork can be left natural, which requires periodic waxing, or it can be painted. If ironwork is to be painted, it should first be covered with red oxide, red lead, or other rust-resisting paint. A finish coat should be applied of flat alkyd paint - not high gloss enamel or latex - of chemical composition compatible with the rust coat. Minimal paint should be applied so that detail is preserved. Flat black is most often an acceptable color. Ironwork should not be painted the same color as the architecture it relates to, since it blends into the building, thus lessening its ornamental value.

Other types of fencing such as chain link or wire are less desirable than the traditional alternatives but can be adapted to a historical property if placed in an inconspicuous location and painted or covered by plant material, such as ivy.

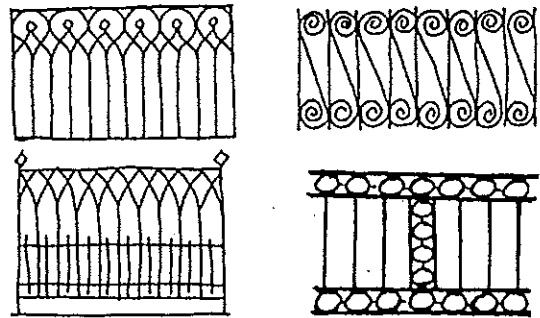

TYPICAL ORNAMENTAL
CAST IRON DESIGNS

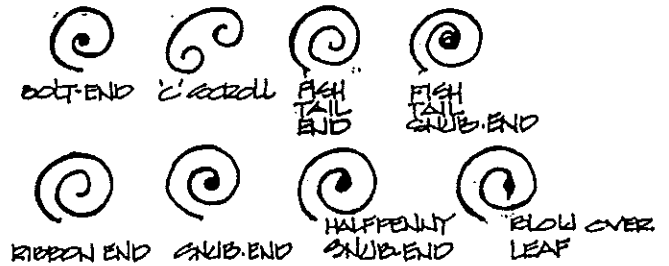

TYPICAL CAST IRON SCROLLS

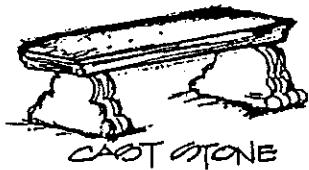

BENCHES

SITE FURNITURE

Antique or reproduction benches of wood (most often teak) cast iron and cast stone can be incorporated in the landscape. Other wooden site fixtures, such as trash cans, and contemporary intrusions, such as, satellite dishes and metal buildings should be carefully sited out of normal vision and with no visual link to the significant features of a historic property.

STREET FURNITURE

In a commercial district, street furniture usually includes benches, trash receptacles, bollards, signage, newspaper racks, and mail collection boxes. It is unusual to find a downtown area with historic street furniture, since such elements undergo a lot of abuse and are replaced fairly often. Street furniture should be aesthetically pleasing and at the same time functional. Functional street furniture is comfortable to use, made of long lasting materials, and designed to be as vandal proof as possible. The style of new street furniture should be contemporary, but at the same time compatible with the character of the historic commercial district. It might also be appropriate to reconstruct former streetscape elements deemed significant in the history of the downtown.

PLANTING

Non historic plant material may be selectively removed if it distracts from the architectural style of the house. Assistance should be obtained in advance to determine the significance of the existing plant materials to insure that unique varieties are not destroyed.

Early gardens may be determined through a detailed site inspection. Variations in texture and color of similar plants may reveal what once was a path. The outline of former planting beds may still be visible through the remains of edging materials. Glazed brick borders of decorative shapes and set in patterns, such as sawtooth edging, were used as edging for Victorian gardens. Certain plants (flowers & vegetable) may continue to survive long after an original garden is abandoned.

New planting should be located or arranged to be consistent with the period of architecture reflected in the structure and with landscape design trends of that period. It is also desirable to introduce only those plant materials that would have been available at the time the structure was built or at a later period deemed important in the historic development of the property.

Plant materials in a commercial district typically consist of street trees, shrubs contained in planting beds, and seasonal flowers. Street trees are usually placed in the sidewalk or medians. Tree grates usually made of cast metal, provide protection for the base of trees, allow rainwater to enter a roof drop under them and are set flush with the adjacent walk to adjacent walk to avoid hazardous changes in elevation in and around public walk areas. Street trees are not necessarily historic. It is important in commercial zones to select a tree appropriate to the location. The mature height and width of the tree should be a major consideration. It is particularly desirable to select a tree that is appropriate to the historic character of the district and will not obstruct the significant facades of the commercial buildings. Tree varieties have been classified as to their hardiness to withstand urban conditions with limited availability of water. This information should be reviewed when considering street tree selection. Other desirable characteristics to consider include fall color, leaf shape, tree form, flower, or fruit. It is important in an urban situation to select a non-fruiting variety in ornamental fruit trees. Ongoing

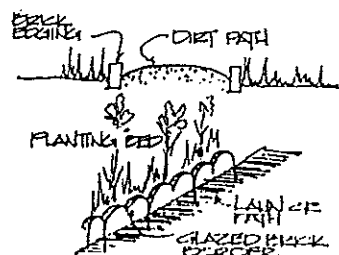

PATH AND GARDEN BORDERS

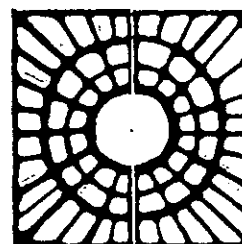

TREE GRATE

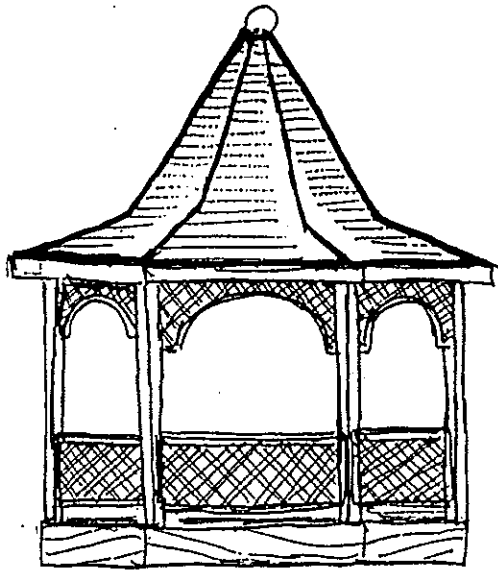

GAZEBO

maintenance of street trees should also be a consideration in selection. For example, Pin Oaks drop leaves almost year around. Require constant clearing at storefronts and around walks. This type condition can be a great aggravation to shop and property owners.

OUTBUILDINGS

Outbuildings associated with a historic properties might be utilitarian or merely fanciful additions to the landscape. Detached kitchens, smoke houses, barns, springhouses, greenhouses, servant quarters, and tool sheds are examples of functional outbuildings that assisted in getting daily chores accomplished. Gazebos and summer houses are outbuildings that added to the enjoyment of a property. The repair of existing outbuildings should utilize as much original material as possible. Replacement materials should duplicate the original in composition and design. In rebuilding a former outbuilding that had been lost, pictorial and physical evidence should be used to insure the accuracy of the reconstruction. The design of a new or replacement of a former outbuilding without the assistance of sound documentation should be contemporary and respect the surrounding historic character of the property. New outbuildings which should be incorporated into a Historic site with care include gazebos, carports, tool shops, guest houses, etc.

MECHANICAL AND ELECTRICAL EQUIPMENT

Air conditioning equipment should be screened from primary vision. Plant material, fencing or lattice work are two methods of establishing a screen. The best solution should be one which is compatible with and draws from the details of the building or landscape. In some areas such equipment may be best placed away from the house. Window air conditioners are discouraged but if provided should be placed inboard (flush with the building face) and the exposed side painted the color of the exterior to reduce the impact of its presence. These units should be placed on the side or rear of the building, not in the front elevation. Television antennas should be placed on the low,

rear side of the roof so as not to be visible from the street. Gas, water and electric meters should be located on the side or rear. If intrusive, the meter should be screened by planting and/or painted the color of the foundation or exterior walls as appropriate. Overhead wiring should be kept to a minimum and if possible placed underground.

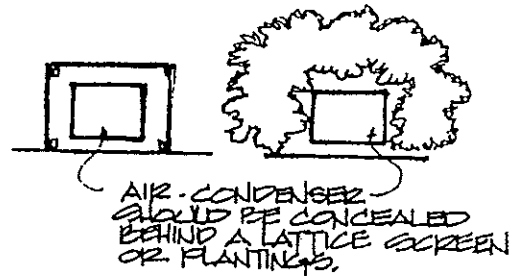

PLAN VIEW

AIR CONDITION

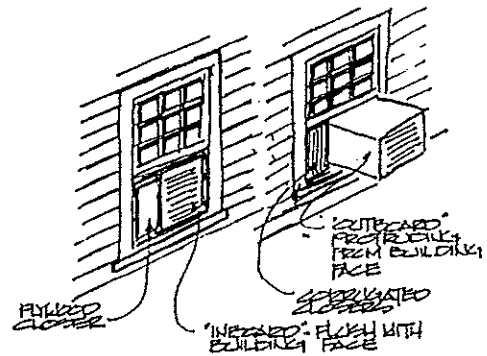

WINDOW AIR CONDITIONERS

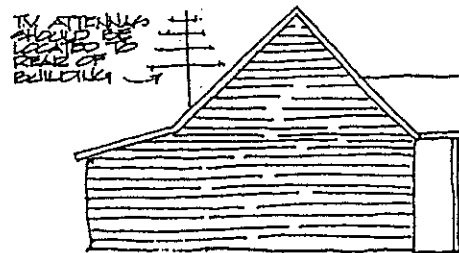

T.V. ANTENNAS

SITE: SOURCES OF INFORMATION

Lighting

Baroni, Daniele The Electric Light: A Century of Design. New York: Van Nostrand Reinhold, 1983.

Dietz, Ulysses G. Victorian Lighting: The Dietz Catalogue of 1860. New York: American Life Foundation, 1982.

Myers, Denys Peter Gaslighting in America: A Guide for Historical Preservation. Washington, D.C.: U.S. Dept. of the Interior, 1978.

Fencing

Gayle, Margot Victorian Ironwork: The Wickersham Catalogue of 1857. Philadelphia: The Athenaeum, 1977.

Martin, George A., ed. Fences, Gates and Bridges: A Practical Manual. Brattleboro, Vt.: Stephen Greene Press, 1974.

Menten, Theodore Art Nouveau Decorative Ironwork. New York: Dover Publications, Inc., 1981.

Murray, John Cast Iron. London: John Murray (Publishers) Ltd., 1985.

Sloane, Eric Our Vanishing Landscape "Fences and Walls". New York: Ballantine, 1975.

Southworth, Susan and Michael Ornamental Iron Work. Boston: David R. Godine, Publisher, 1978.

Zelinsky, Wilbur. "Walls and Fences." in Changing Rural Landscapes. edited by Ervin H. and Margaret J. Zube. Amherst: University of Massachusetts Press, 1977.

Planting

Favretti, Rudy J. and Joy Putnam For Every House A Garden. Chester, Connecticut: The Pequot Press, 1977.

Favretti, Rudy J. and Joy Putman Landscapes and Gardens for Historic Buildings. Nashville: American Association for State and Local History 1978.

Highstone, John Victorian Gardens. San Francisco: Harper and Row, Publishers, 1982.

Outbuildings

Strombeck, Janet A. and Richard H. Gazebos and other Garden Structure Designs. Delafield, Wi.: Rexstrom Co. Inc., 1983.

STRUCTURE

FOUNDATION

Settling of Footings

Uneven settling of a building's foundation is most commonly caused by poor footings or the absence of footings. Without footing support, a pier or wall may have a tendency to bore into the ground or compact the area around it causing settling. Footings can be installed beneath existing unsupported piers. An experienced contractor should perform this work except for the most experienced layman/owner. Typically, the structure above the pier must be jacked up and supported while the pier is removed, a footing poured and the pier rebuilt.

Masonry Deterioration & Replacement

Pier deterioration can be caused by shifting loads, poor tuckpointing of the masonry, or deteriorating brick. Masonry piers should be checked for cracks and crumbling mortar. Open cracks should be repaired with mortar. The content of the new mortar should be compatible with the physical characteristics of the existing mortar. Uneven foundations threaten the entire structural integrity of the building.

Rule: Always explore and identify the likely cause of the problem before deciding how to solve it. Foundation problems can be caused by soil conditions, water problems or the load the foundation must carry. Each cause requires a different type solution.

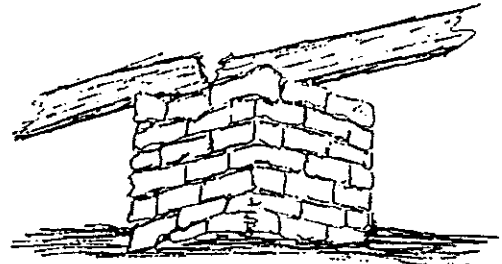

PIERS WITHOUT FOOTING

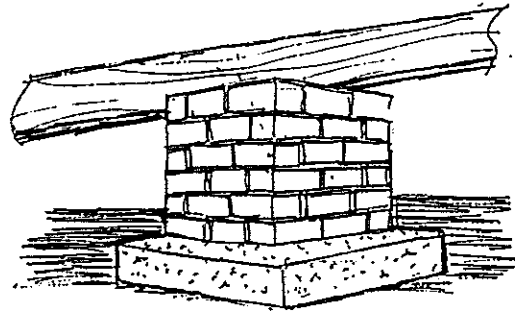

PIERS WITH FOOTING

Infill Material

Originally, the underside of houses were open. As styles changes, wood lattice was one method used as infill between piers to screen the crawl space. It provides continuous ventilation to the sub-floor structure and ease of access to the crawl space. Wood lattice should be pressure treated and installed a minimum of two inches above the ground. Consideration should be given to the more authentic appearance PVC Lattice which is rot resistant.

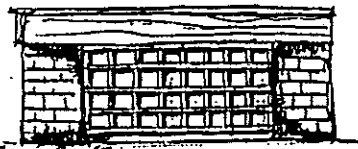
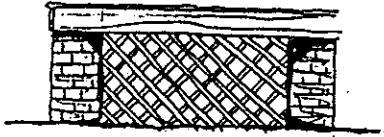

LATTICE

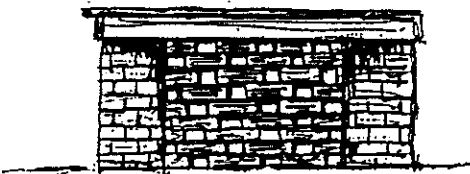

PIERCED BRICK

Concrete masonry in its natural finish is not particularly compatible with brick which was most often used for pier construction. Brick wall is a better alternative. If concrete brick is used, recess the infill area an inch or more behind the outside plane or the piers, paint the block a dark complementary color and cover with Lattice. If the infill is flush with brick piers finish with thin stucco finish and paint. Lattice on top, or planting at foundation may be appropriate if style and date accepts foundation planting. If concrete masonry is used as infill, sub-floor ventilation must be maintained as well, as access to crawl space for periodic inspection.

Pierced brick as infill should be avoided except in uniquely appropriate construction. Color, size, and pointing of the brick should be matched to piers. Brickwork of infill should not be tied to piers.

VENTILATION

Vents in the foundation walls should be located near building corners for optimum cross ventilation.

EXTERIOR WALLS

Existing sound original or authentic wood siding should be retained if at all possible. New wood should be prepared by scraping and sanding for painting. Dust and clean surfaces with a combination cleaner/degreaser as necessary. Wood should be primed. Do not leave wood exposed to weather unprotected. Existing wood siding should be wiped clean with liquid sanding agent or household cleaner, thoroughly rinsed with water and allowed to dry before priming and painting.

Loose, blistered or peeling paint surfaces are an indication of moisture problems. This could also be caused by excessive heat or dryness. Corrective steps should be taken, otherwise, paint will merely mask a condition that will reoccur. Mildew can be removed with a mixture of bleach, detergent and water. The surface should be feathered by sanding so paint will be smooth. All wood must be thoroughly dry before priming.

Paint removal can be done manually with paint scraper, wire brush, putty knife or sandpaper or with chemical removals. Water based solutions have the least harmful effect. Thick, paste-type removals can be used for vertical surfaces. The use of power tools can harm the surface if not controlled well. Sand-blasting should never be considered.

PAINT TYPE

Do not paint with oil base paint over latex paint without priming. The opposite holds true as well. These two types of paint have different expansion properties and they can cause premature maintenance requirements. Latex is a more flexible material while oil is more rigid. Each has its pros & cons and must be evaluated for the specific circumstances.



TYPES OF WOOD SIDING

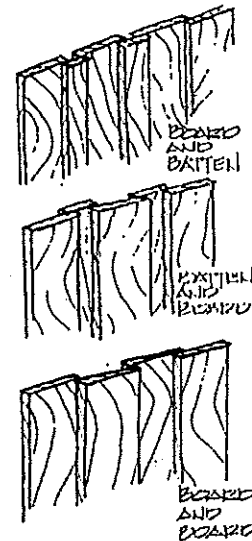

VERTICAL BOARD SIDING

VINYL AND ALUMINUM SIDING

These types of siding may alter the architectural characteristics of a structure. When placed directly over existing wood siding it may trap moisture in the wall thus creating a potential for decay. If this type of siding is used, old siding should be removed and the thickness and profile of the original siding duplicated.

DECAY DAMAGE

Moisture penetration is a serious threat to the building because it can cause decay. When decay is noted the problem should be identified and corrected. Areas where water penetration might occur include: gutters, downspouts, flashings, siding, roof and foundation. Water damage can be detected through peeling paint, cracks in the siding, or missing shingles. Poor drainage around a foundation, many times caused by inadequate removal of rainwater, also results in water damage.

When damage is noted the following steps should be taken. First, remove all deteriorated wood and replace with pressure treated wood. Stabilize deteriorated wood with epoxy treatments when appropriate. Provide adequate ventilation of all enclosed areas. Inspect annually for any repeat of water damage.

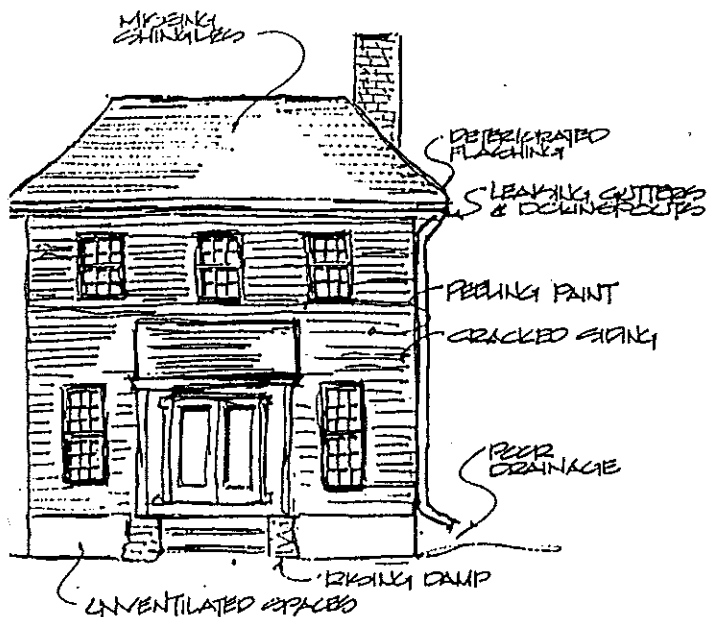

**POSSIBLE AREAS
FOR WATER PENETRATION**

INSECT DAMAGE

Signs of termite infestation in wood include: half-round vertical tunnels on wood foundation walls and piers and pathways at horizontal openings where pipes enter the house or the foundation wall. If termite damage is noted, preventive steps a property owner can take include: the removal of all scrap wood in close proximity to the house (in the crawl space under the house or in the yard); the poisoning of soil and wall surfaces beneath the building with chemicals that attack the termites, and the removal of all infested wood. A professional in

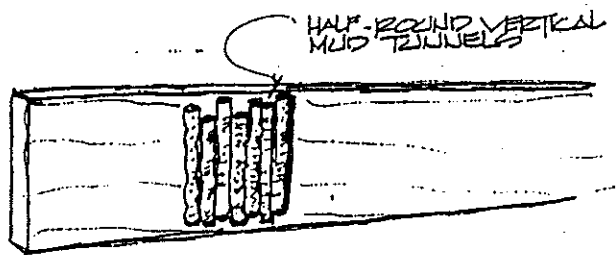

TERMITE INFESTATION

termite control should be consulted in addressing such problems.

During storage, wood becomes prone to beetle attack. Holes with piles of fresh bore dust is a sign of beetle attack. Preventive precautions include: treating uninfected wood with a film-forming finish that prevents the insect from laying it's eggs on the wood; treating wood with wood preservatives; taking steps to prevent moisture penetration; and removing any rotted or decay wood. Infested wood should be burned and any exposed wood should be treated with an insecticide. Because beetles have a long life, wood should be treated every three to four year intervals.

Carpenter ants are another pest to wood. These insects attack from under the crawl space. Pests can be controlled by the use of pesticides and fumigants on the ground around the building foundation.

MASONRY

Moisture penetration causes deterioration in masonry. A brick wall with high moisture content will deteriorate over time. Moisture penetration occurs in cracked joints or at points where different materials and planes meet, at the sills of windows, at faulty gutters and downspouts, and on eroded brick surfaces. "Rising damp" is another indication of water penetration in masonry. This condition is caused by moisture in the ground traveling from the ground up into the wall itself and being visible on the wall surface. Excessive moisture in masonry facilitates deterioration as a result of the "freeze/thaw" cycle.

An important purpose of tuckpointing of mortar joints between masonry units is to protect the brick against moisture penetration. If existing mortar is cracked or can easily be pulled away with the fingers, it should be repointed. It is of critical importance that joint style be matched to maintain the original character of a historic property. The

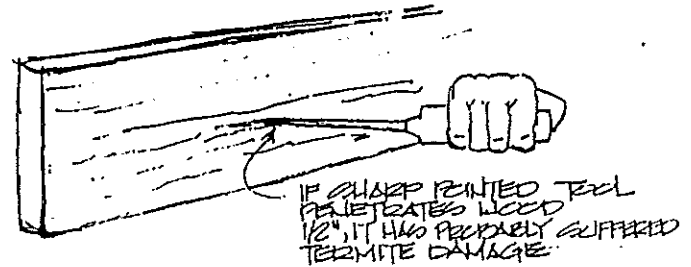

CHECKING WOOD FOR TERMITE DAMAGE

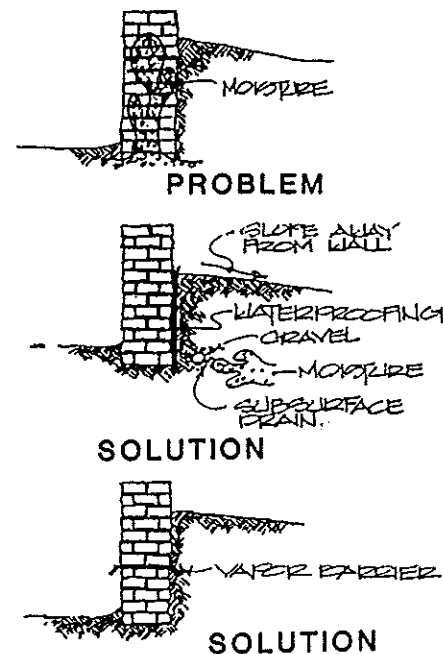

RISING DAMP

alteration of the joint profile on a building can result in a totally different appearance to the structure.

STUCCO

Continual weathering action results in deterioration to stucco. Age and lack of maintenance also create problems. Many times the cracking of a stucco exterior breaks the bond between the stucco coating and the brick backing. Modern stucco construction is not recommended in repairing damaged surfaces, since it differs in consistency and color. Portland cement stucco can cause damage to the brick and the lime mortar due to its rigidity and hardness. The expansion coefficient of modern stucco is different from the comparable older material thus potentially creating separation, often times with the brick itself. Also portland cement stucco does not allow water to escape, but rather forces it up the wall. This can cause deterioration of the brick and mortar.

EXTERIOR WINDOW AND WINDOW TREATMENTS

Because windows are exposed to the elements, they require regular maintenance and paint. Window sills generally receive the most punishment of exterior features and may need replacing if they are allowed to rot. Sills should be made with pressure treated hardwood.

Broken panes and cracked and missing putty can cause moisture penetration and rapid deterioration of wooden sashes. Steps for reglazing are as follows: (1) cracks in the window frame should be filled with putty, (2) loose paint should be scraped and repainted, (3) loose and cracked glazing putty should be removed and re-applied, and (4) finally, the light (glass pane) should be replaced.

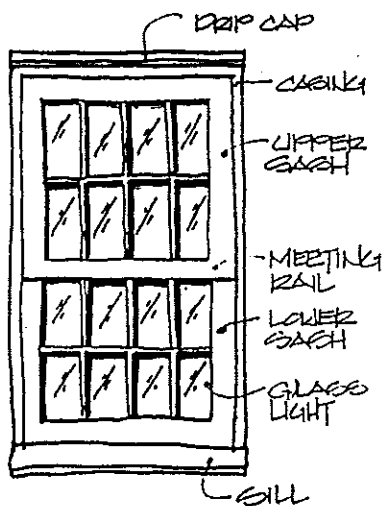

DESCRIPTION OF WINDOW

Storm windows can be installed to have minimal visual distraction to the appearance of a building. Aluminum frames should be painted to match window trim. The installation of storm windows on the interior is preferred over exterior storm windows.

Awnings are not only aesthetically pleasing, but they also provide a means of cooling and weather protection. Three types of available fabric awnings are acrylic (longest-lasting), vinyl-coated canvas, and canvas. Metal awnings were introduced after World War II and are inappropriate for anything other than post-war bungalow style homes.

PORCHES AND STOOPS

Porches often have to be repaired due to their constant exposure to the elements. If repairing or reconstructing the porch is necessary, pressure treated wood should be used when framing the support members. Wood preservatives or waterproofing chemicals should be used on the floorboards. Wood steps or stringers should not make direct contact with the ground. A concrete footing can be placed to support the stain stringers.

Rails and spindles should be kept painted and sealed to prevent rot. Deteriorated railings and spindles should be replaced. Porch floor boards often warp or buckle. To assist in preventing buckling, preservatives and primer for floor paint should be used. If flooring is carrying too much weight it can cause the porch to deteriorate around columns. Porch rafters and beams can deteriorate from moisture penetration caused by leaking gutters or poor flashing. Porch column repair is necessary when the base of posts and columns deteriorate. Columns should be removed and repaired by removing decayed sections and new components fabricated. To keep out of contact with moisture, columns should be reset on a metal base.

Porches should be enclosed with transparent materi-

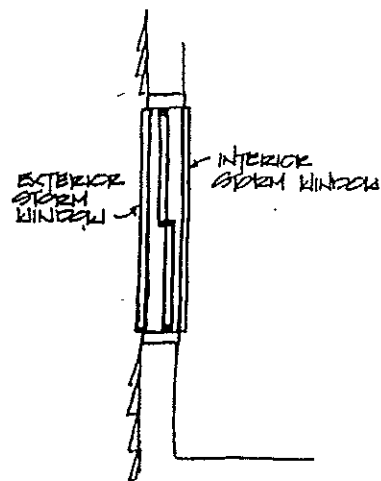

STORM WINDOW OPTIONS

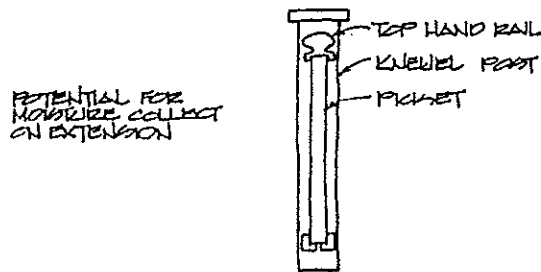

PORCH RAILING

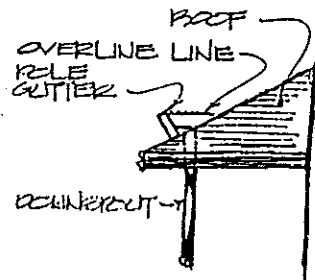

POLE GUTTER

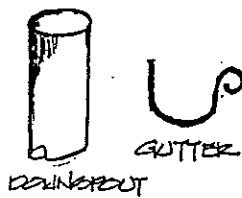

MODERN HALF ROUND GUTTER

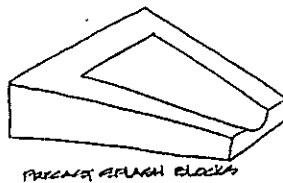

SPLASH BLOCK

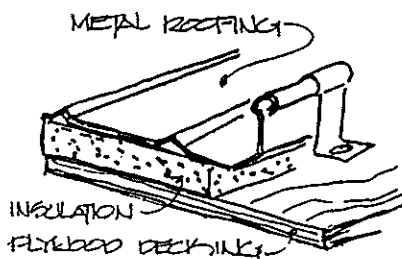

METAL ROOF

als such as glass or screen. New materials should be compatible to the original structure.

GUTTER AND DOWNSPOUTS

Modern gutters are seldom appropriate for historic properties. Pole gutters, a historic technique to direct rainwater from the roof, are recommended as an alternative to modern gutters. These gutter consist of a board placed a foot back from the eave and covered with metal flashing. The collected water is directed to the ground through a downspout that extends through the roof. If modern gutters are used the half round is the most desirable type. Round downspouts are also preferred to the rectangular corrugated types.

Typical problems with gutters and downspouts are clogging, leaking and rotting. They must be regularly maintained and cleaned. Splash blocks made of stone should be used to direct water from the downspout and away from the foundation.

ROOF

Different roofing materials may be found on historical homes. These are slate, clay, cedarshakes, asphalt, composition and metal.

Metal roofs should be repaired with new replacement pieces. New materials should be chemically compatible with existing materials to avoid erosion.

Slate is a long lasting roofing material. The most significant problem with a slate roof can be broken and/or missing slates. Replacement with new slates is a practical and economical solution. Replacement slates should be matched to the existing slates. For total replacement but to retain the slate look, a new synthetic material is now available that visually duplicates the appearance of slate.

Historic designs in pressed metal shingles are now readily available for roof repair and replacement. To match an existing roof and replace damaged shingles, appropriate companies should be contacted to determine the availability of certain shingle designs. Existing metal roofs can be preserved through frequent inspections and keeping the surface painted.

Roofing cement can be used to patch asphalt roofing. Black tar should never be used for the repair of metal or slate roofs. Replacement asphalt shingles can be added to an existing asphalt roof with roofing nails or roof cement.

NEW ROOFING

To replace roofing material in total, it is important to remove all former roof material - many times found in layers on the roof structure. Composition shingles should never be placed over slate or metal roofing materials. All flashing and gutters should be checked and, where necessary, replaced. Adequate roof ventilation should also be an important consideration. Add attic vents, where necessary.

Asphalt shingles are considered a contemporary but acceptable roofing material for historic structures. It is important to consider the color and texture of the new roof in relation to the historic character of the structure.

STOREFRONTS

The first step in a storefront rehabilitation is to evaluate the existing storefront. Is it original? Is it a replacement? If it is a replacement, is it important and should it be preserved? The condition of the storefront is another important consideration. Do surfaces need only repair or replacement or is a new storefront necessary? Following this evaluation, a plan of action should be developed. If minor repair

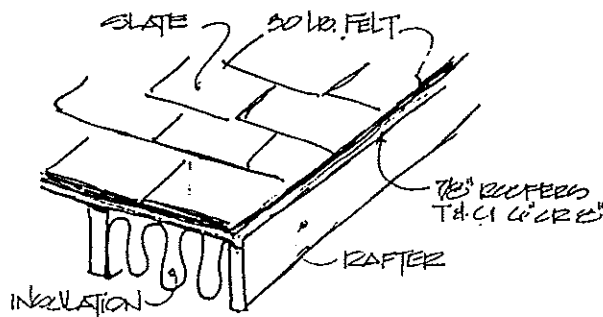

SLATE ROOF

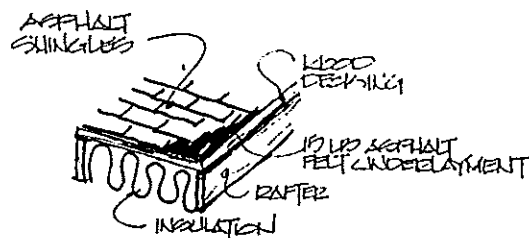

ASPHALT SHINGLE ROOF

is all that is required, this should be carried out following preservation standards, such as the appropriate methods of cleaning masonry or metal surfaces.

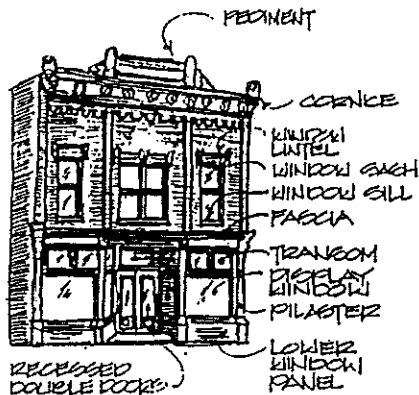

TYPICAL STOREFRONT

A replacement storefront should be designed to be compatible in size, scale, color, material, and character with the building. In some cases, a replacement storefront is a reconstruction of the original storefront when photographic documentation is available. Without proper documentation, a new design can be contemporary but should duplicate the feeling of an open storefront. This is best achieved through the use of glass doors, windows, and transoms. A new storefront should be constructed of materials typically associated with a storefront, such as brick, wood, cast iron, and/or glass and contain elements typically associated with a storefront, such as the lintel, transoms, piers, display windows, paneled doors, and kickplates. There should be a distinction between the primary retail entrance and secondary entrances to the upper floors. New entrances usually need to be recessed, since health and safety code requirements generally restrict out-swinging doors.

AWNINGS

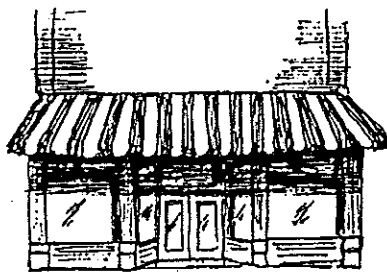

STOREFRONT WITH AWNING

Awnings were common on storefronts in the late 1800's and early 1900's. Awnings are functional elements since they provide shelter and control the amount of sunlight that can penetrate a building. Contemporary canvas awnings have a life expectancy of approximately five years, which can be extended with occasional cleaning with detergent and water. Canvas awnings with a vinyl coating are more durable and last longer. Awnings should be installed without damaging the storefront. Aluminum awnings are inappropriate, since they create a harsh, nonhistoric character to a building.

COLOR SELECTION

To carry out a period paint color scheme, the property owner should first attempt to identify the original paint colors associated with the structure. This can be determined through collecting a number of paint chips at various locations on the structure and observing the layers of paint color. A professional trained in paint color analysis should be consulted to correctly identify the original paint scheme. The State Historic Preservation Office or the Georgia Trust for Historic Preservation might be consulted for sources of paint color analysts.

If this approach is not feasible, observation of the paint color chips by the property owner and a general knowledge of historic paint colors can be utilized. There are a number of reference books available to assist in determining colors appropriate to the period of the structure. Not only are colors in themselves historic, but the combination of colors were also used historically.

SOURCES OF INFORMATION

General References

Chambers, J. Henry Cyclical Maintenance for Historic Buildings. Washington, D.C.: Technical Preservation Services, U.S.A. Department of the Interior, 1976

Hanson, Shirley Preserving and Maintaining the Older Home. New York: McGraw-Hill, 1983.

Labine, Clem, and Flaherty, Carolyn, Eds. The Original Old House Journal Compendium. Woodstock, N.Y.: Overlook Press, 1980.

Morton III, W. Brown; Hume, Gary L.; and Weeks, Kay D. The Secretary of the Interior's Standards for Rehabilitation and Guidelines for Rehabilitating Historic Buildings. Washington, D.C.: Technical Preservation Services, 1983.

Preservation League of New York State A Primer: Preservation for the Property Owner. Albany, N.Y. Preservation League of New York State, 1978.

Sherwood, Gerald New Life For Old Dwellings. Washington, D.C.: U.S. Dept. of Agriculture, 1979.

Stahl, Frederick A. A Guide to the Maintenance, Repair, and Alteration of Historic Buildings. New York: Van Nostrand Reinhold, 1984.

Stephen, George Remodeling Old Houses Without Destroying Their Character. New York: Knopf, 1972.

Technical Preservation Services Respectful Rehabilitation: Answers to Your Questions About Old Buildings. Washington, D.C.: U.S. Dept. of the Interior, 1982.

U.S. Dept of the Army Historic Preservation Maintenance Procedures. Washington, D.C.: U.S. Army AG Publications Center, 1977

Watkins, Arthur Martin The New Complete Book of Home Remodeling, Improvement, and Repair. Piermont, N.Y.: Building Institute, 1979.

Wood Siding

Feist, W.C., and Oviatt, A.E. Wood Siding - Installing, Finishing, Maintaining. Washington, D.C.: U.S. Dept of Agriculture, 1983.

Johnson, Ed Old House Woodwork Restoration: How to Restore Doors, Windows, Walls, Stairs, and Decorative Trim to Their Original Beauty. Englewood Cliffs, N.J.: Prentice-Hall, 1983.

Phillips, Morgan W., and Selwyn, Judith E. Epoxies for Wood Repairs in Historic Buildings. Washington, D.C.: U.S. Dept. of the Interior, Technical Preservation Services, 1978.

U.S. Forest Service Wood Decay in Houses. Washington D.C.: U.S. Dept of Agriculture, 1986.

Masonry

Conway, Brian D. Stucco. Springfield, Ill.: Illinois Dept. of Conservation, Div. of Historic Sites, 1980.

Grimmer, Anne E. A Glossary of Historic Masonry Deterioration Problems and Preservation Treatments. Washington D.C.: National Park Service, Preservation Assistance Division, 1984.

Mack, Robert C., "Repointing Mortar Joints in Historic Brick Buildings," in Preservation Brief no.2. Washington, D.C.: U.S. Dept. of the Interior, Technical Preservation Services.

Smith, Baird M. Moisture Problems in Historic Masonry Walls. Washington, D.C.: National Park Service, Preservation Assistance Division, 1986

Windows

"A Restorationist View of Windows." Old House Journal. June 1974.

Association for Preservation Technology "Architectural Glass: History and Conservation." Bulletin.
Vol. 13, 1981

Myers, John H. "The Repair of Historic Wooden Windows," in Preservation Brief no. 9. Washington,
D.C.: U.S. Dept. of the Interior, Technical Preservation Services, 1981.

"Special Window Issue" Old House Journal. April 1982.

Roofs

Association for Preservation Technology "Early Roofing Materials," in Bulletin. Vol. 2, 1970.

Sweetster, Sarah M. "Roofing for Historic Building," in Preservation Brief no. 4. Washington, D.C.:
U.S. Dept. of the Interior, Technical Preservation Services, 1978.

Storefronts

Berk, Emanuel Downtown Improvement Manual. Chicago, Illinois: Planners Press, 1976.

Jandl, H. Ward, "Rehabilitating Historic Storefronts," in Preservation Briefs, Washington, D.C.:
National Park Service, Preservation Assistance Division.

Longstreth, Richard Main Street, a Guide to American Commercial Architecture. Washington, D.C.:
The Preservation Press, 1987.

Paint Color

Dornsife, Samuel J. and Moss, Roger Jr. Victorian House Colors. Nashville, Tenn.: American
Association for State and Local History.

Miller, Kevin H., ed. Paint Color Research and Restoration of Historic Paint. Ottawa, Ont.: Association
for Preservation Technology, 1977.

Moss, Roger Century of Color: Exterior Decoration for American Buildings 1820 - 1920. Watkins Glen,
N. Y.: American Life Foundation, 1981.

Weeks, Kay D., and Look, David W. "Exterior Paint Problems on Historic Woodwork", in Preservation
Brief no. 10. Washington, D.C.: U.S. Dept. of the Interior, Technical Preservation Services, 1982.